

# Origin of Life: I

## Monomers to Polymers

# Synthesis of Monomers

Life arose early on Earth

## 1. Conditions

1. Liquid Water
2. Reducing or Neutral Atmosphere
3. Energy Sources

2. Originally thought atmosphere was  
NH<sub>3</sub>, CH<sub>4</sub>, H<sub>2</sub>O, H<sub>2</sub>

Miller-Urey Experiment

Now Believe      CO<sub>2</sub>, H<sub>2</sub>O, N<sub>2</sub>

3. Energy Sources

Ultraviolet Light (No Ozone)

Lightning

Geothermal (Lava, Hot Springs, Vents, ...)

# Miller-Urey Experiment

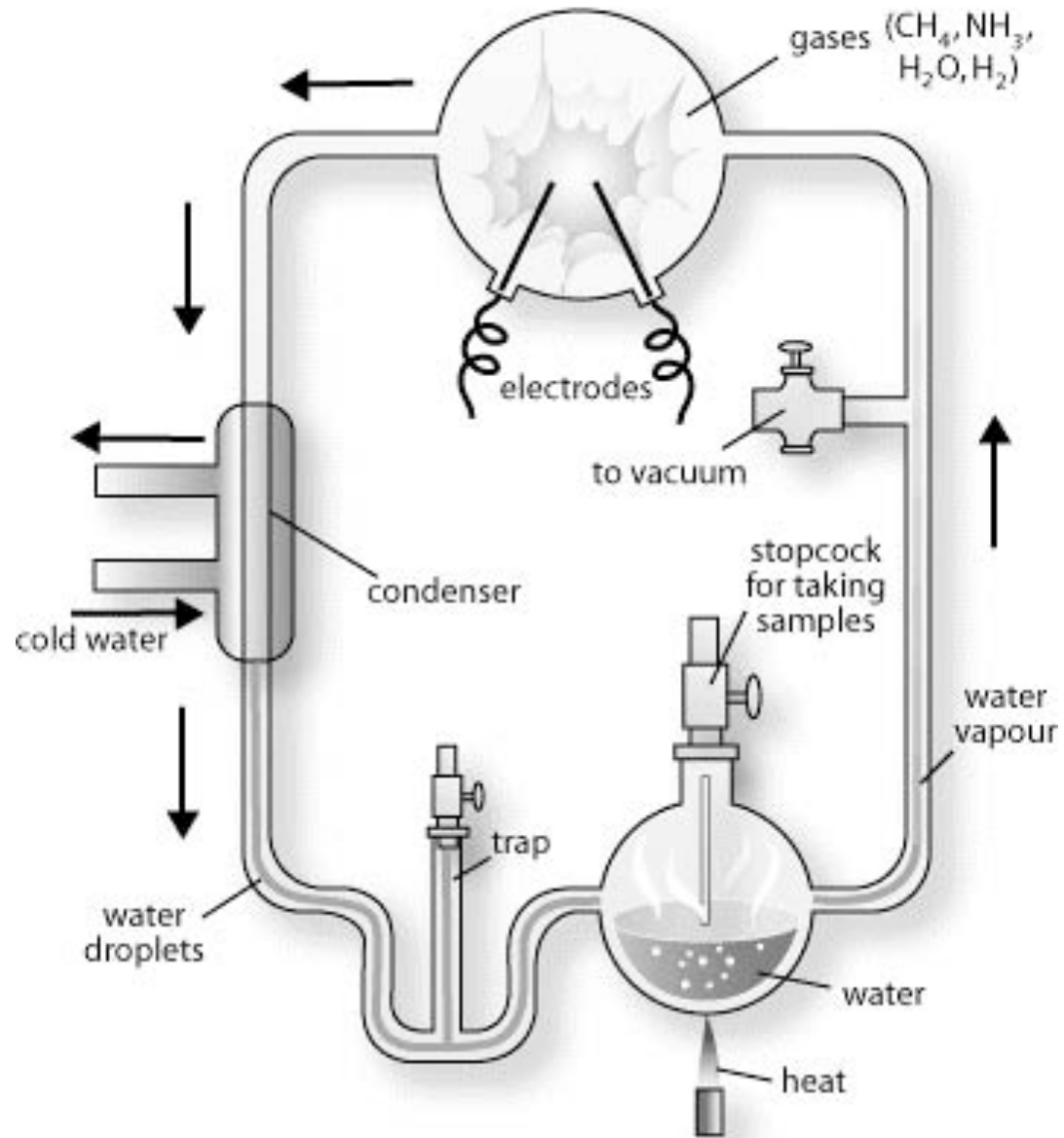

<u>COMPOUND</u>	<u>Relative Yield</u>
<b>Glycine</b>	270
Sarcosine	21
<b>Alanine</b>	145
N-methylalanine	4
Beta-alanine	64
Alpha-amino-n-butyric acid	21
Alpha-aminoisobutyric acid	0.4
<b>Aspartic acid</b>	2
<b>Glutamic acid</b>	2
Iminodiacetic acid	66
Iminoacetic-propionic acid	6
Lactic acid	133
Formic acid	1000
Acetic acid	64
Propionic acid	56
Alpha-hydroxybutyric acid	21
Succinic acid	17
Urea	8
N-methyl urea	6

# How did Amino Acids form in Miller-Urey Experiment?

## Strecker Synthesis



Reactive

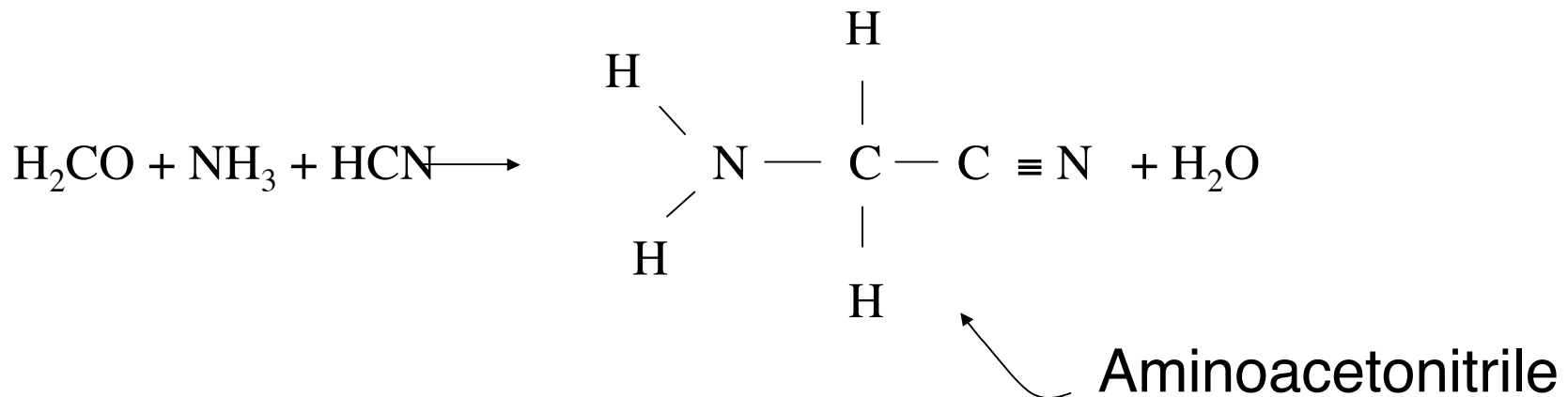

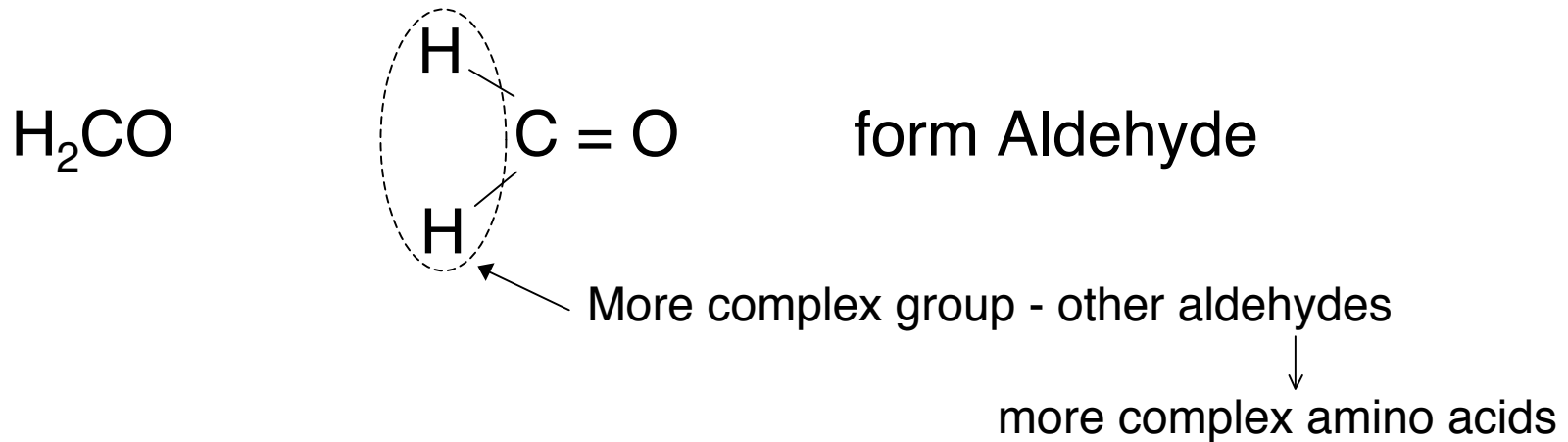
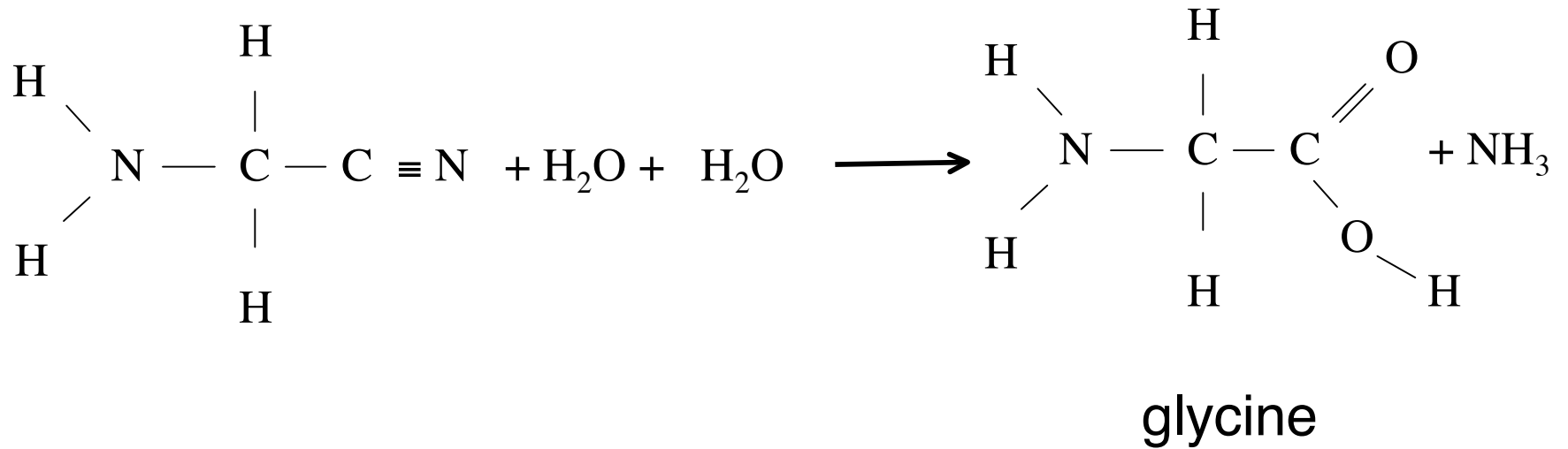

Lower yield if atmosphere was  $\text{N}_2$ ,  $\text{CO}_2$ ,  $\text{H}_2\text{O}$

(If  $\text{H}_2/\text{CO}_2 > 2$ , get good yield)

# Problems with Miller-Urey

Atmosphere was  $\text{N}_2$ ,  $\text{CO}_2$ ,  $\text{H}_2\text{O}$

$\text{NH}_3$ ,  $\text{CH}_4$  would react  $\longrightarrow$   $\text{N}_2$ ,  $\text{CO}_2$

Try  $\text{N}_2$ ,  $\text{CO}_2$ ,  $\text{H}_2\text{O}$  in Miller-Urey simulation

Only get trace amounts of glycine

Need  $\text{CH}_4$  to get more complex amino acids

Need  $\text{H}_2/\text{CO}_2 > 2$  to get much of any amino acid



## Miller-Urey with Cosmic Rays

A group in Japan has obtained good yields of amino acids from slightly reducing gases  
(CO<sub>2</sub>, CO, N<sub>2</sub>, H<sub>2</sub>O)

When they used high energy protons  
(simulate cosmic rays)

Apparently not Strecker Synthesis  
(Low abundance of aminoacetonitrile)

# Building Blocks of Nucleic Acids

Not formed in Miller-Urey, but some intermediates were

## 1. Ribose Sugar:

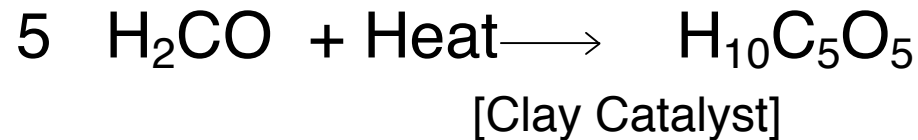

## 2. Bases



### b) Pyrimidines

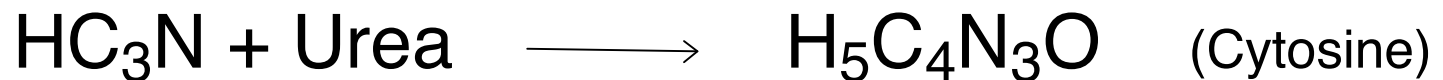

### 3. Phosphate

Rock Erosion

Less understood than amino acids

#### **Other Possibilities for building blocks:**

Seafloor Vents

Interstellar Molecules

Comets

# Alternative Delivery

Molecular clouds - strongly reducing, contain many molecules used in Miller-Urey ( $\text{H}_2$ ,  $\text{NH}_3$ ,  $\text{H}_2\text{O}$ ,  $\text{CH}_4$ ) and intermediates ( $\text{HCN}$ ,  $\text{H}_2\text{CO}$ ,  $\text{HC}_3\text{N}$ ) and possibly glycine

Problem: These would not have survived in part of disk where Earth formed

But interstellar ices  $\longrightarrow$  comets

Evidence from similar molecules

(e.g.  $\text{C}_2\text{H}_2$ ,  $\text{CH}_4$ ,  $\text{HNC}$ , ...)

Clearly indicates interstellar chemistry

Cratering record on moon, ...

⇒ heavy bombardment early in history

Comets and their debris could have brought  
large amounts of “organic” matter to Earth  
(and maybe some of the oceans)

Some evidence for non-biological amino acids  
in layer deposited after asteroid impact 65  
million years ago

# Sources of Organic Molecules

Quantitative comparison by Chyba & Sagan, Nature  
1992, Vol. 355, p. 125

Currently, Earth accretes  $\sim 3.2 \times 10^6 \text{ kg y}^{-1}$  from  
interplanetary dust particles (IDP)

$\sim 10\%$  organic carbon  $\Rightarrow 3.2 \times 10^5 \text{ kg y}^{-1}$

$\sim 10^3 \text{ kg y}^{-1}$  comets

$\sim 10 \text{ kg y}^{-1}$  meteorites

$\sim 10^3 \times$  more at  $4.5 \times 10^9 \text{ yr ago}$  (?)

(cratering record)

UV + reducing atmosphere  $2 \times 10^{11} \text{ kg y}^{-1}$

But if  $\text{H}_2/\text{CO} \lesssim 0.1$  IDP's dominant source

So if atmosphere very neutral, IDP's may have been important

Most of mass in IDP's in range of size  $\sim 100 \mu\text{m}$

mass  $\sim 10^{-5} \text{ g}$

Complex structure - composites of smaller grains some carbon rich

Enhanced deuterium implies low T

Deuterium enhancement also found in interstellar molecules

May imply connection back to interstellar chemistry

2 kinds  
(mass ranges)  
can supply  
organic matter

1. Interplanetary  
dust particles  
( $m \lesssim 10^{-5}$  g)

2. Smaller  
meteorites  
( $m \lesssim 10^8$  g)

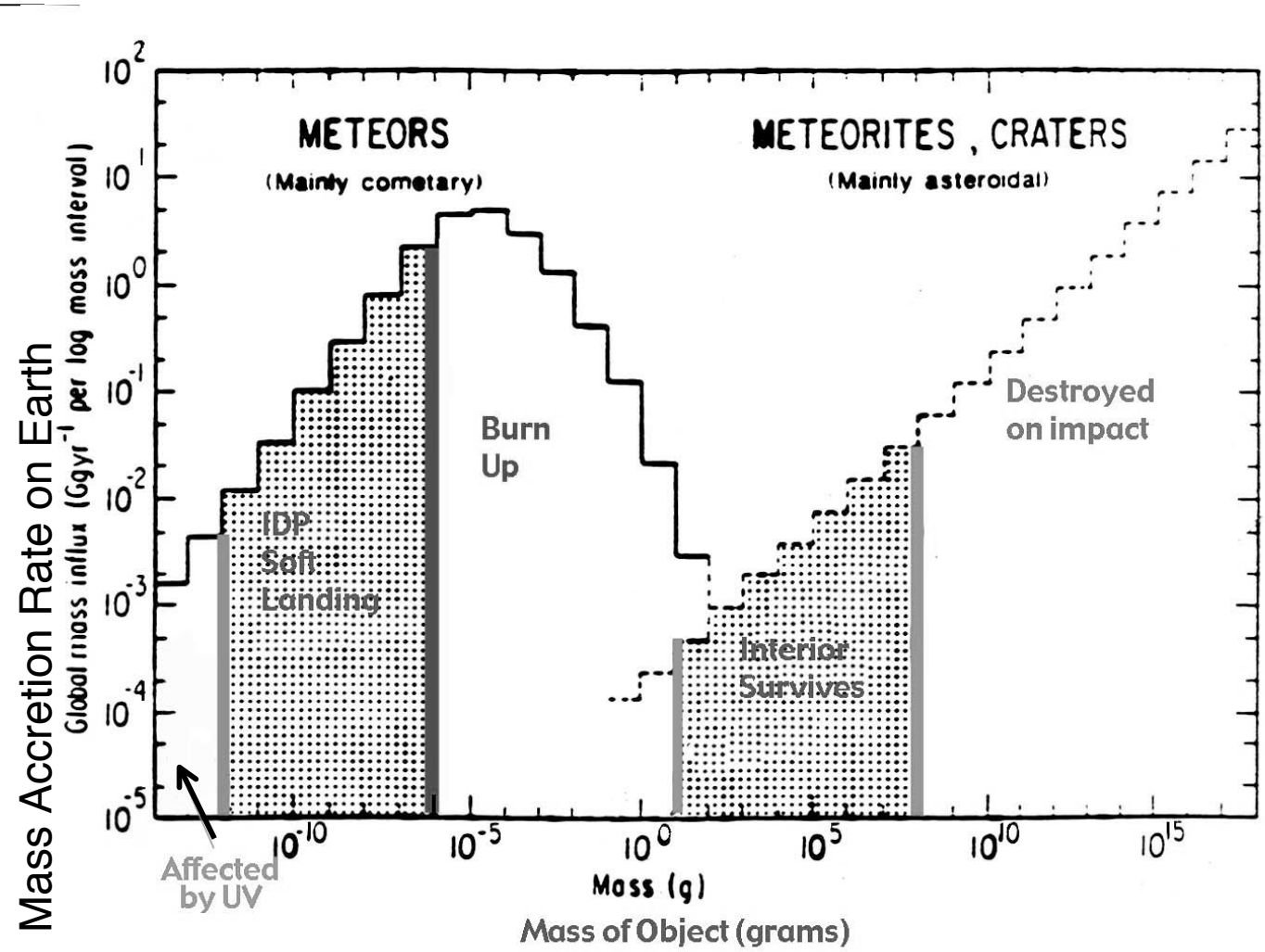

FIG. 1 Infall rate of meteoritic matter on Earth (adapted from ref. 5). Intervals where organic matter can survive passage through atmosphere are shaded. The curve on the right is based on the relation<sup>5</sup>  $N=0.54 r^{-2.1}$  ( $N$ =number of impacts per Myr,  $r$ =radius in km), for an assumed density of  $3 \text{ g cm}^{-3}$ . The corresponding mass accretion rate ( $\text{Ggyr}^{-1}$ ) between  $r_1$  and  $r_2$  is  $15.83 (r_2^{0.9}-r_1^{0.9})$ .

E. Anders (1989) Nature, 342, 255



# Alternative Sites

Locally reducing environments

1. Ocean vents

Sources of  $\text{CH}_4$  and  $\text{H}_2\text{S}$

Current Vents have ecosystems based on energy from chemicals - not photosynthesis

$\text{H}_2\text{S}$  → Bacteria → Clams, Tube Worms

Pre-biotic amino acid synthesis?

## 2. Inside Earth

Many bacteria now known to live deep (~ 2 miles) in Earth. Energy from chemicals, adapted to high temperature.

Genetic makeup is very ancient.

## 3. Hot Springs

Bacteria may be important in precipitating minerals. Adapted to high T and ancient.

# Synthesis of Polymers

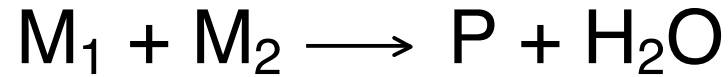

← more likely in liquid H<sub>2</sub>O

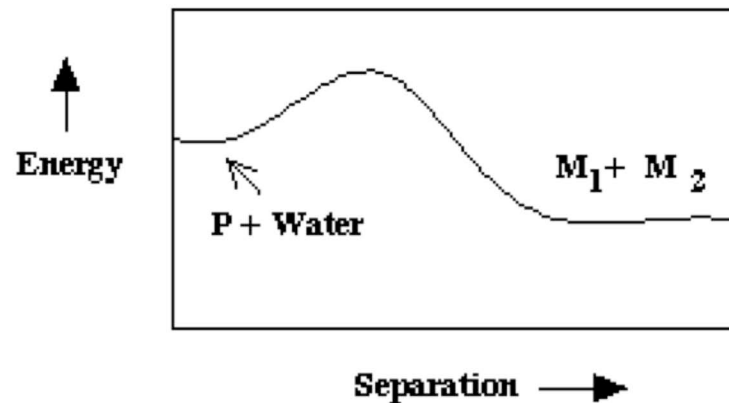

Solutions

Remove H<sub>2</sub>O (Drying, Heat)

Sydney Fox → Proteinoids

Energy Releasing Reactions (H<sub>2</sub>NCN or HC<sub>3</sub>N)

Catalysts: Clays

Problem is worse for Nucleic acids because more complex

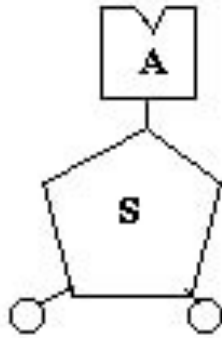

nucleoside

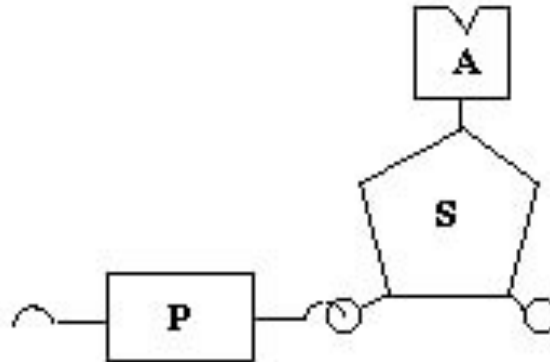

nucleotide

↑  
Monomers of nucleic acids

# Synthesis of Adenosine

Base on 1' Carbon (Why?)

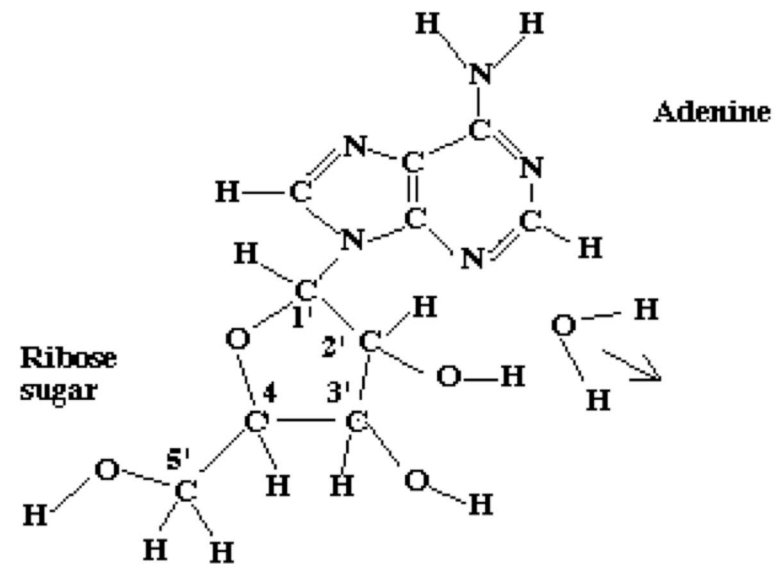

Also phosphates

3' & 5' carbons

Otherwise, you are likely to get  
Misalignment

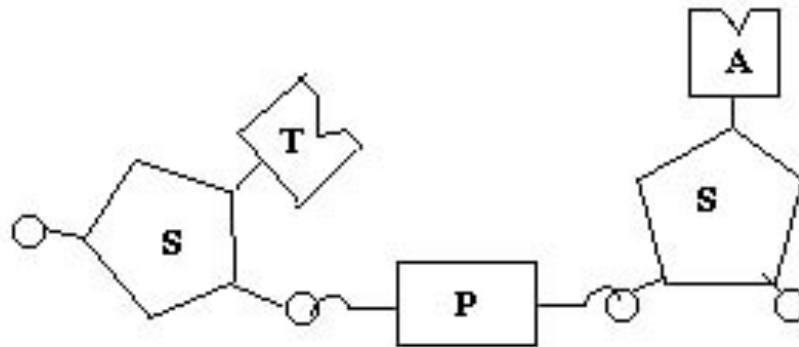

Leslie Orgel has had some success in getting high percentage of correct linkages, in presence of Zinc ions.

## Experimental Results

Sugar + base + heat yield some nucleosides

Activated nucleosides + phosphoric acid +  $Zn^{+2}$

Get polymers up to 50 nucleotides in length

linkages (mostly) correct

# The Odds

- We need to get an “interesting” polymer
  - Enzyme
  - Self replicator
- Properties of polymer depend on
  - Order in which monomers combine
- If we combine monomers at random,
  - How likely to get something interesting?



# Statistics

- What unlikely event happened just before the Super Bowl?

# Statistics of an unlikely event

Random reactions in primordial soup?

Unlikely event versus many trials

Probability Primer: Consider tossing 10 coins

Probability of all heads = product of prob.

$$P = \left(\frac{1}{2}\right)\left(\frac{1}{2}\right)\left(\frac{1}{2}\right)\left(\frac{1}{2}\right)\left(\frac{1}{2}\right) \cdots \left(\frac{1}{2}\right)^{10} = \frac{1}{1024}$$

Probability of getting 10 amino acids → protein

Chosen from 20 in a particular order

$$\left(\frac{1}{20}\right)^{10} = \frac{1}{1 \times 10^{13}}$$

Based on discussion by  
R. Shapiro

But if you try many times, the chance of success is higher

$$P(r) = \frac{n!}{r! (n-r)!} p^r (1-p)^{n-r}$$

$r$  = # of successes     $p$  = prob. of success on each trial

$n$  = # of trials

$n! = n (n-1) (n-2) \dots 1$

e.g. make  $n = \frac{1}{p}$  (flip all 10 coins 1024 times)

$$P(1) = \frac{n!}{1! (n-1)!} \binom{1}{n} \left(1 - \frac{1}{n}\right)^{n-1} = 0.37$$

Chance of one or more successes = 0.63

For reasonable chance need  $n \sim \frac{1}{p}$

How many do we have to get right?

1. How many atoms?

Lipids	$10^2 - 10^3$
Enzymes, RNA	$10^3 - 10^5$
Bacterial DNA	$10^8 - 10^9$
Bacterium	$10^{11} - 10^{12}$
Human Being	$10^{27} - 10^{28}$

If we choose from H,C, N, O (ignore S,P)

probability of right choice 1/4

So for enzyme:  $(\frac{1}{4})^{10^3} \sim 10^{-600}$

# of trials: R. Shapiro computes

$N = 2.5 \times 10^{51}$  (surely an overestimate)

$n \ll \frac{1}{p}$  for simple enzyme

2. What if we start with amino acids?

Need  $\sim 10^{13}$  trials to get 10 amino acid protein

To get 200 amino acids in right order

$$\left(\frac{1}{20}\right)^{200} = 10^{-260} \quad \text{Hopeless!}$$

Need something besides random combinations

Selection (Natural?)

# Improving the Odds

Many proteins composed of interchangeable segments (Domains)

10 to 250 amino acids

One domain found in ~ 70 different proteins

Intermediate building blocks?

If so, may only need to get enough amino acids in right order for a domain

e.g. 18 amino acid domain

$$P = \left(\frac{1}{20}\right)^{18} = 10^{-23}$$

Also, many variations in amino acids don't destroy function

and many different sequences may be interesting

**GENETICALLY MOBILE MODULES** have been found in many proteins. Two types of these modules, or domains, are shown here. The Fn3 and the GHR domains are examples of fibronectin type III modules. The PapD and CD2 domains are immunoglobulin domains. These modules are linear sequences of amino acids that can fold themselves into consistent, recognizable structures with specific biochemical properties. During evolution, these domains can move as discrete units from one protein to another, which helps new types of proteins to appear.

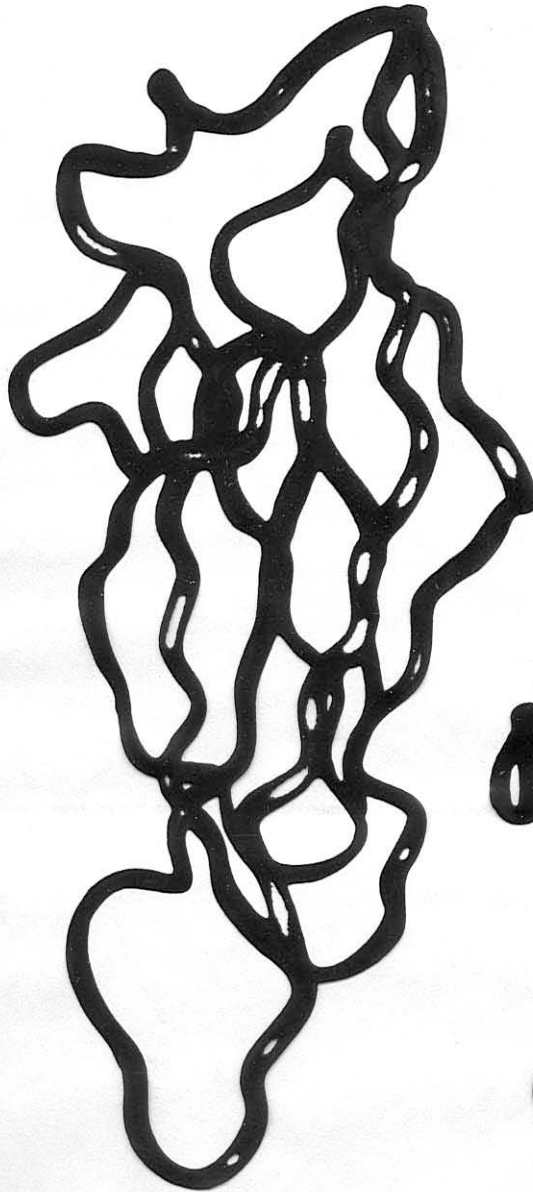

**PapD DOMAIN 1**



**GHR DOMAIN 1**

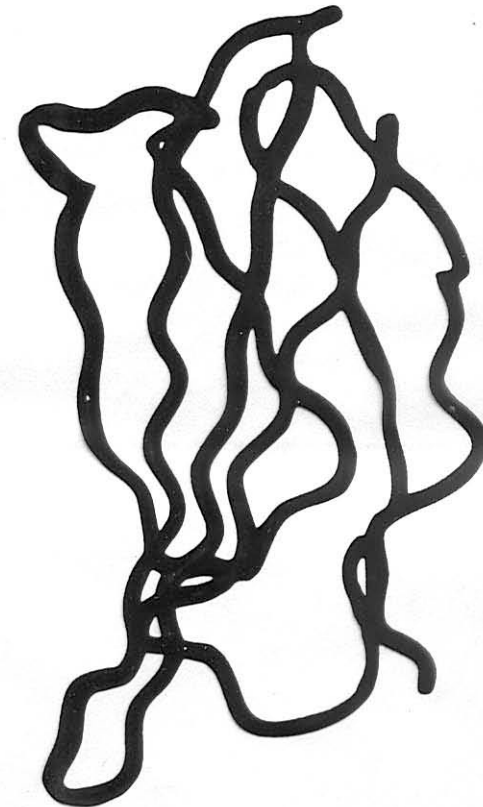

**Fn3 (10TH DOMAIN)**



Scientific American Doolittle & Bork

Oct. 1993, pg. 50

Proteins made of domains, assembled in various ways  
10-250 amino acids for ones containing disulfide bonds

18 - 100 for those without

Of all amino acids available

$$\left(\frac{1}{20}\right)^{40} \quad \text{or} \quad \left(\frac{1}{20}\right)^{18}$$

$$\log_{10} = 40 \log 20 \qquad -18 \log 20$$

$$= -52 \qquad = -23.4$$

$$\text{so } 10^{-52} \qquad 10^{-23.4}$$

Interesting fact on how the improbable happens

1st winner of Texas Lotto lottery

Picked all 6 numbers correctly in the same order as they were drawn.

Each number runs from 1 to 50, and once chosen, cannot be repeated (balls are taken from a box).

So the odds against getting them in order is

$$\left(\frac{1}{50}\right)\left(\frac{1}{49}\right)\left(\frac{1}{48}\right)\left(\frac{1}{47}\right)\left(\frac{1}{46}\right)\left(\frac{1}{45}\right) = \frac{1}{11,441,304,000}$$

You don't need to get them in the same order to win - odds against winning include any combination, so 1 in 16 million