

Life

What is necessary for life?

Most life familiar to us: Eukaryotes

FREE LIVING
Or Parasites

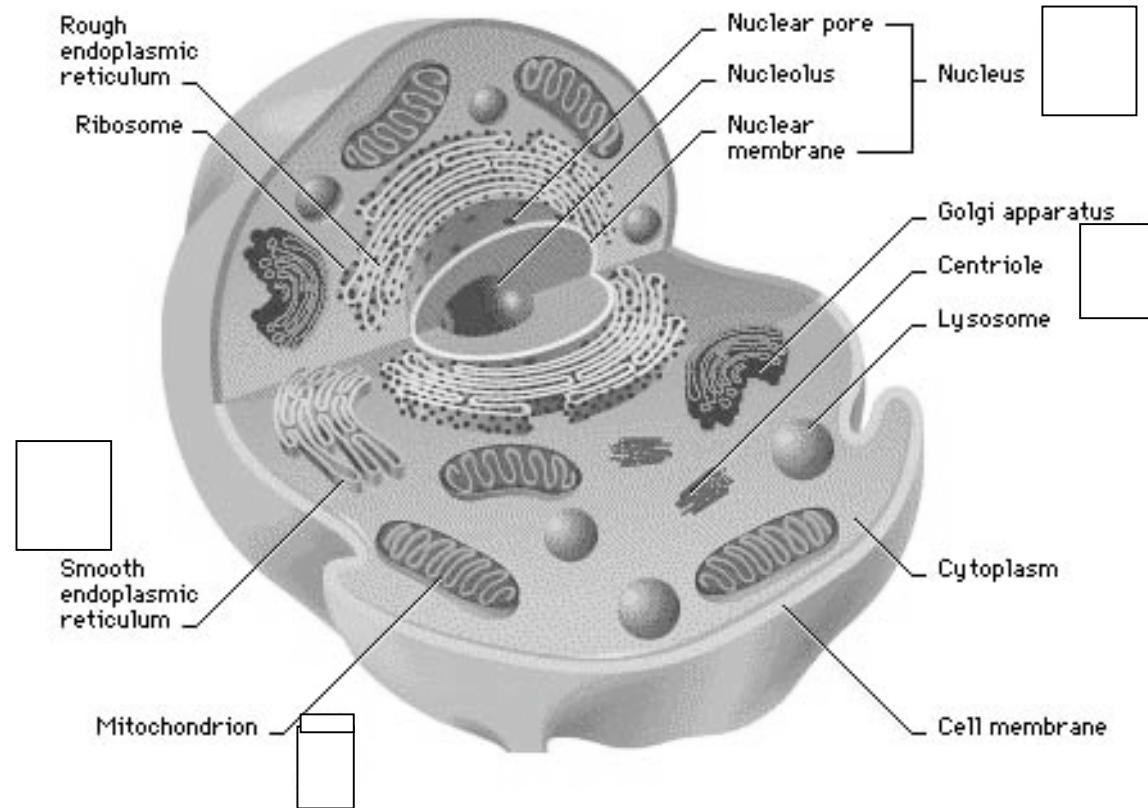

First appeared $\sim 1.5 - 2 \times 10^9$ years ago

Requirements: DNA, proteins, lipids, carbohydrates,
complex structure, $\sim 10^4 - 10^5$ genes

Prokaryotes (Bacteria and Archaea)

First appeared

~ 3 - 4 × 10⁹ years ago

FREE LIVING
Or Parasites

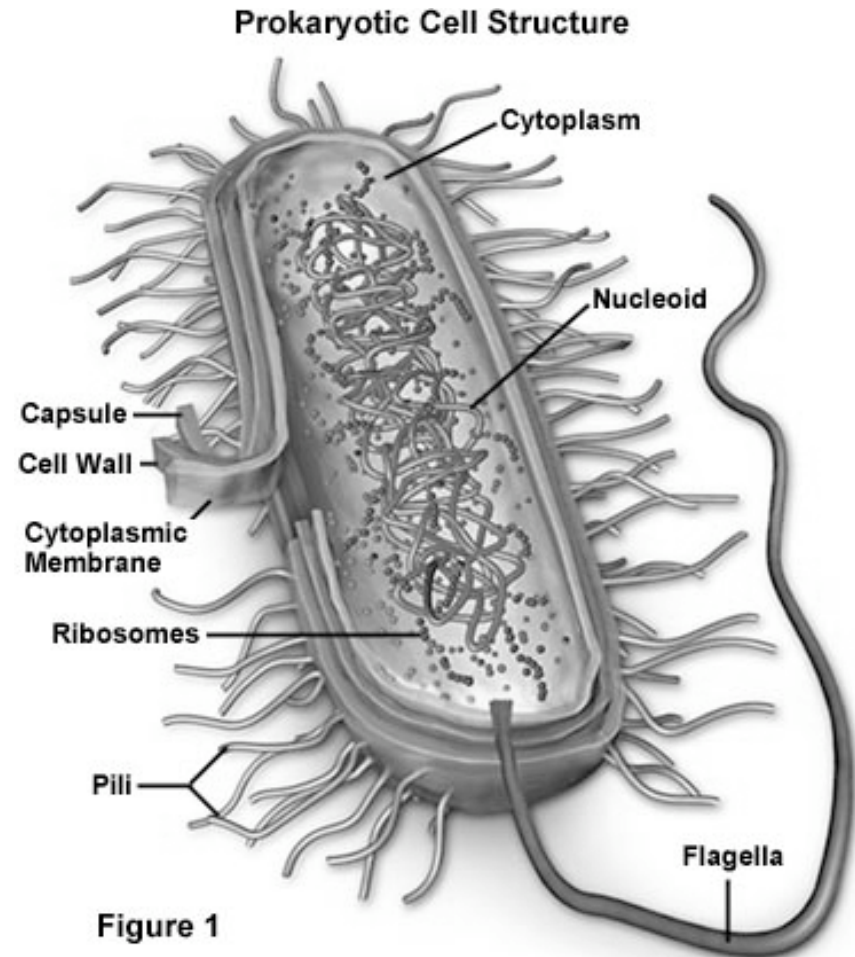

Requirements: DNA, protein, lipids, carbohydrates,
simpler structure, few thousand genes

Viruses

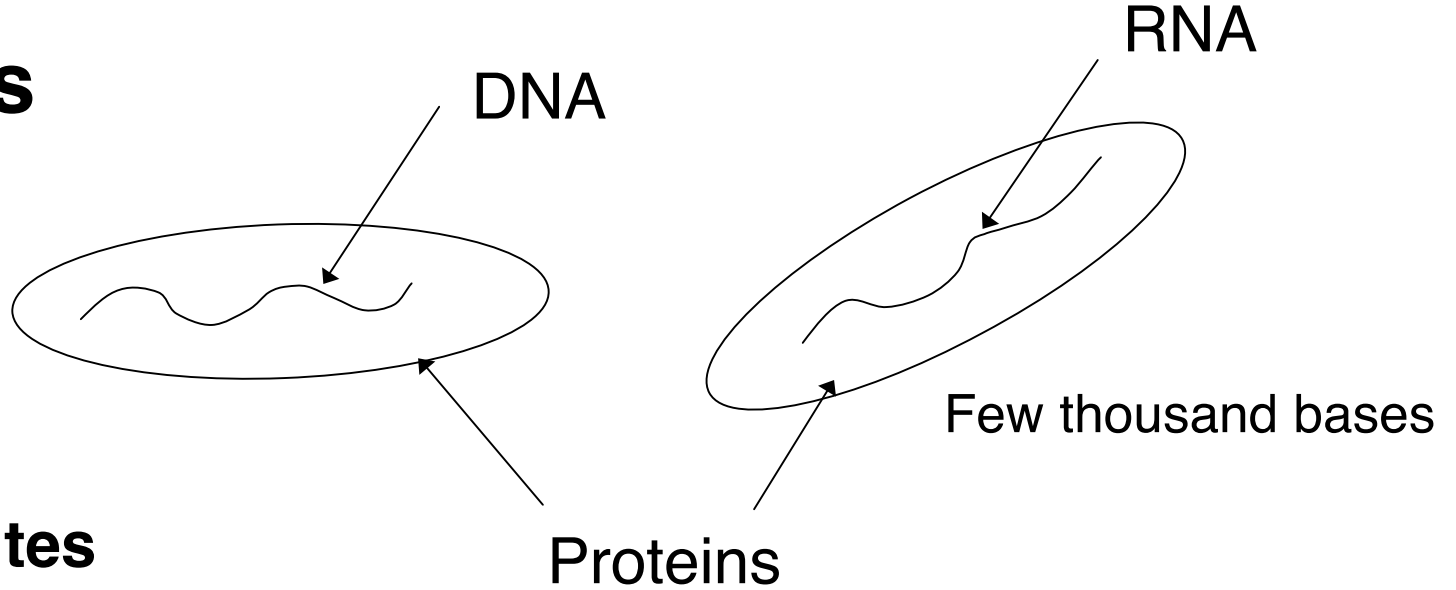

Viroids,
Plasmids

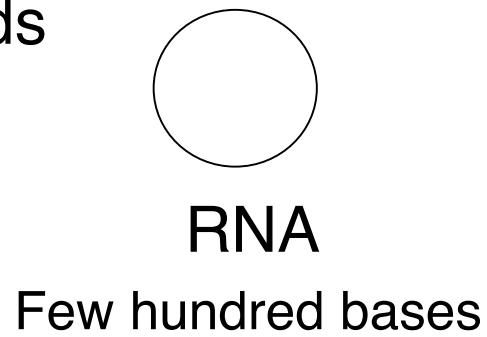

Prions?

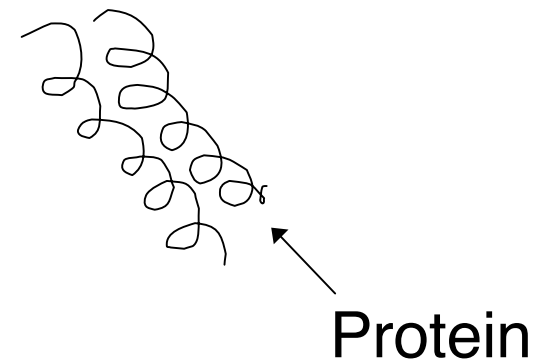

The tobacco-mosaic virus is made up of a strand of nucleic acid encased in a rod of one kind of protein.

TOBACCO MOSAIC VIRUS

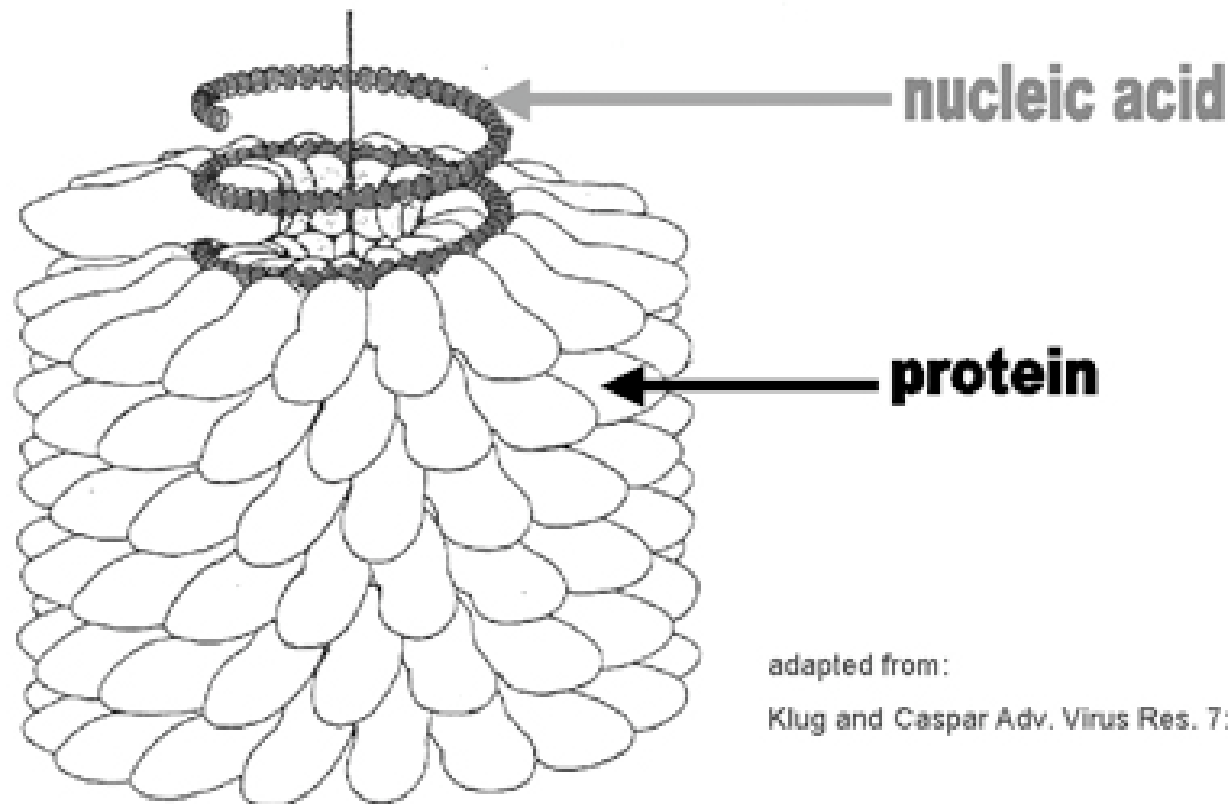

Minimum Requirements for Life

Proteins and Nucleic Acids for simplest
Or maybe only one.

Lipids and Carbohydrates for any thing
more complex than a virus.

These are all macromolecules.

Macromolecules

H, C, N, O
(S)

Proteins made of amino acids (20)
Construction and catalysis (enzymes)

H, C, N, O
(P)

Nucleic acids made of nucleotides

base sugar phosphate

Polymers and Monomers

H, C, O

Carbohydrates made of sugars

Energy (food) + structure

[starch]

[cellulose]

H, C, (O)

Lipids (hydrocarbons + carboxyl)

Membranes + Energy

[water-resistant]

Sugar

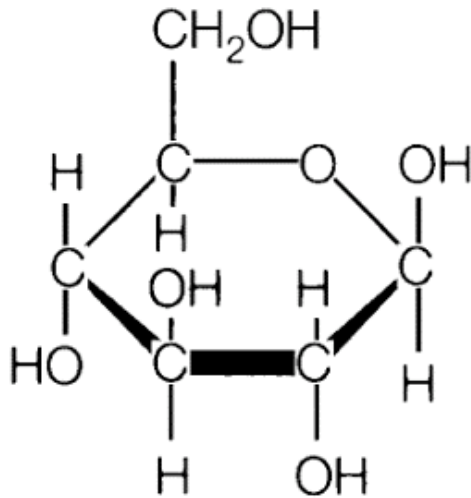

Glucose

Lipids

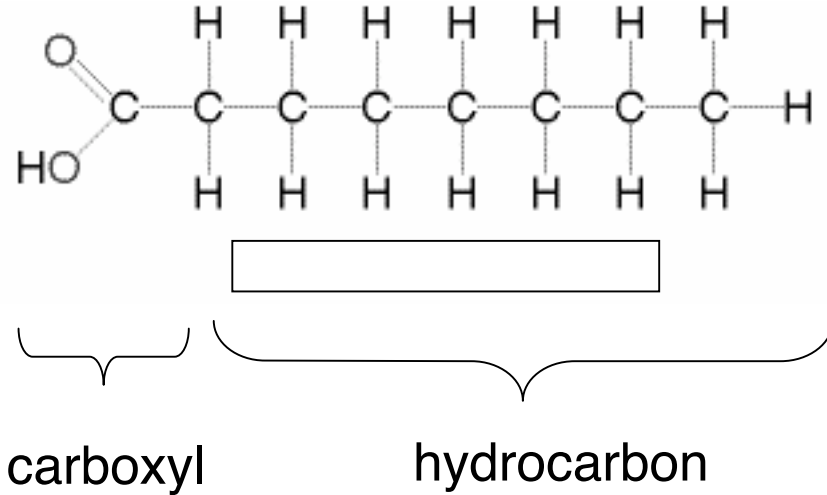

Fatty acid is composed of a hydrocarbon chain with a carboxyl group at one end

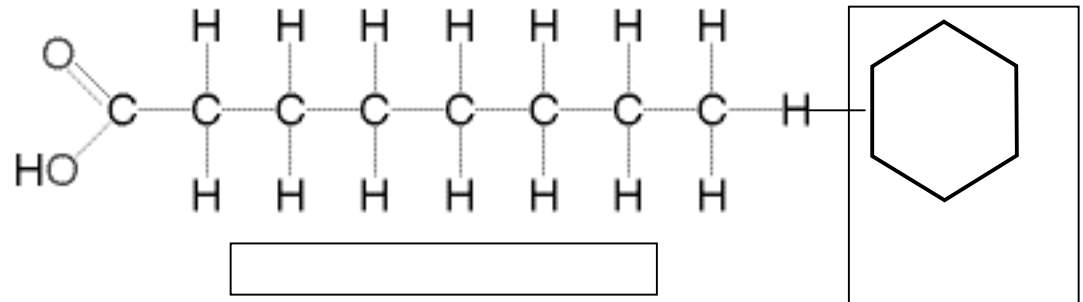

Polysaccharides

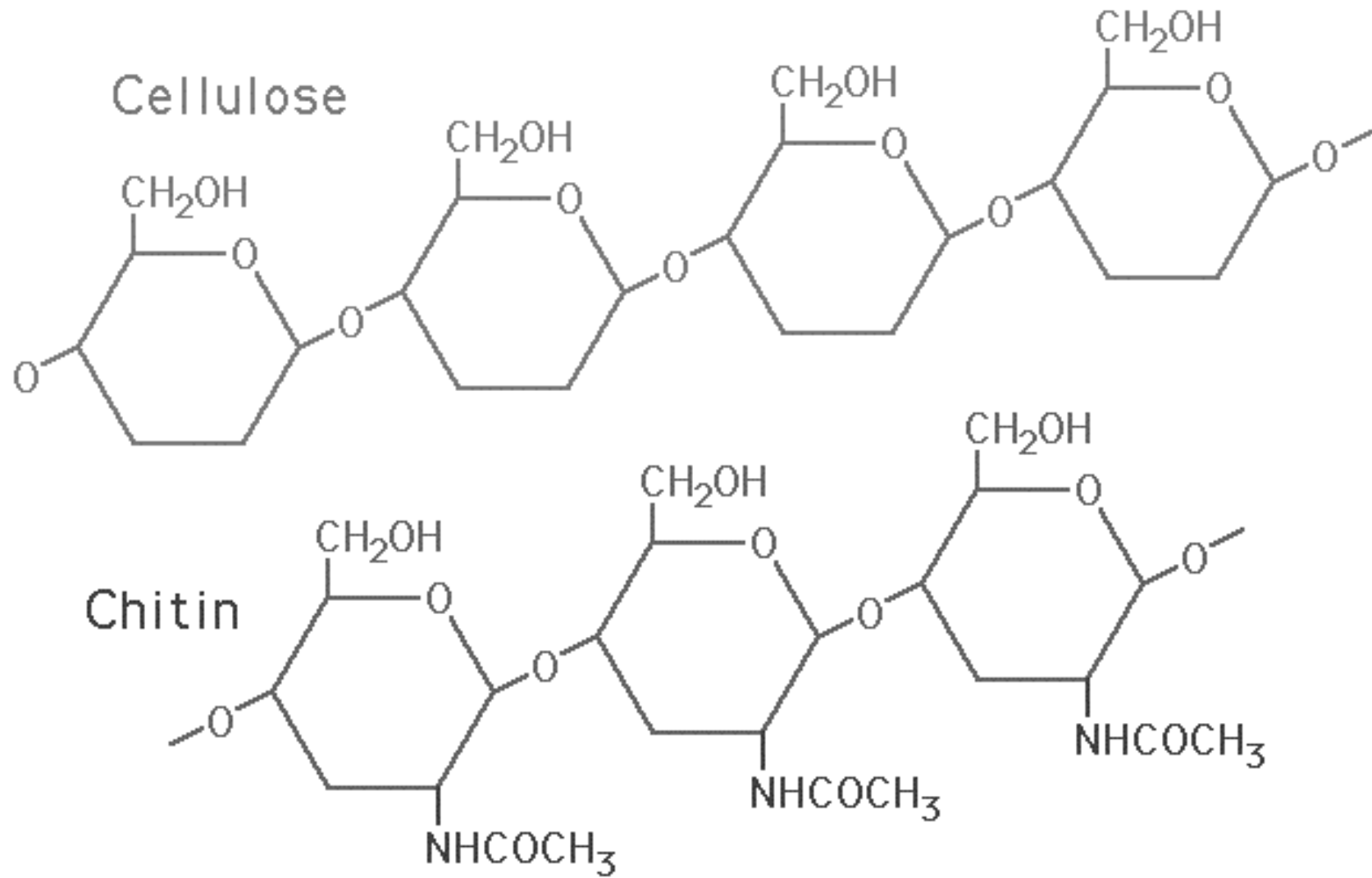

Proteins

Monomers are amino acids

20 kinds

Glycine

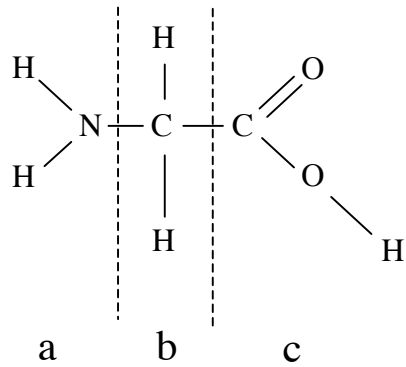

Amino group

carboxyl group

Schematic

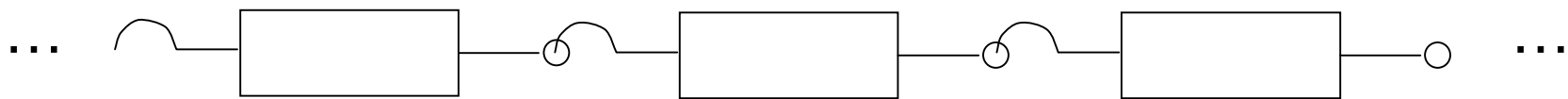
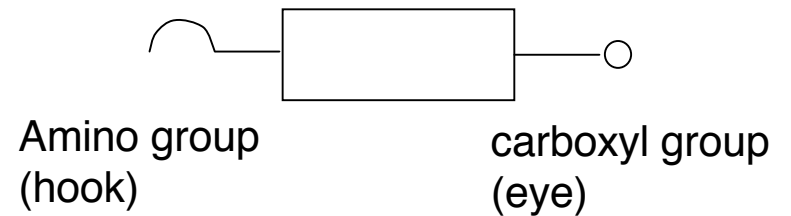

Section of Protein

A Peptide Bond at the Chemical Level

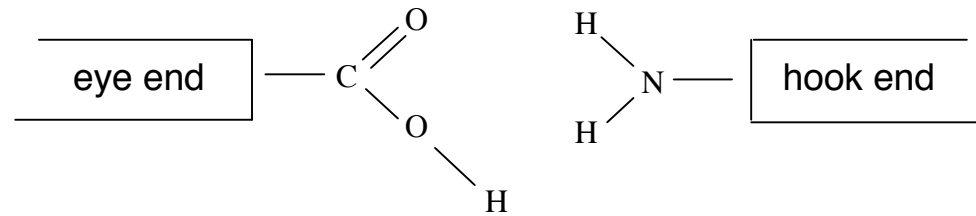

Before

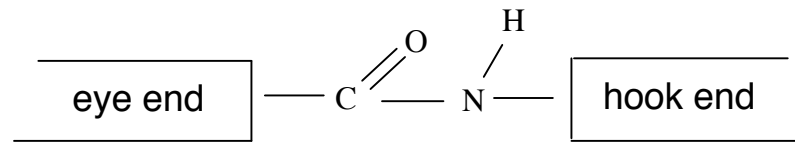

After

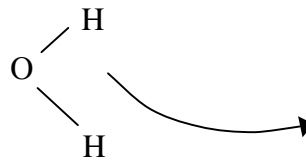

Note that a water molecule must be removed

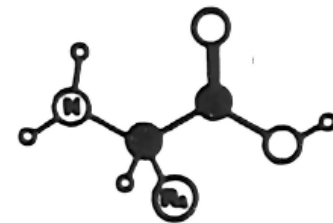

amino acids

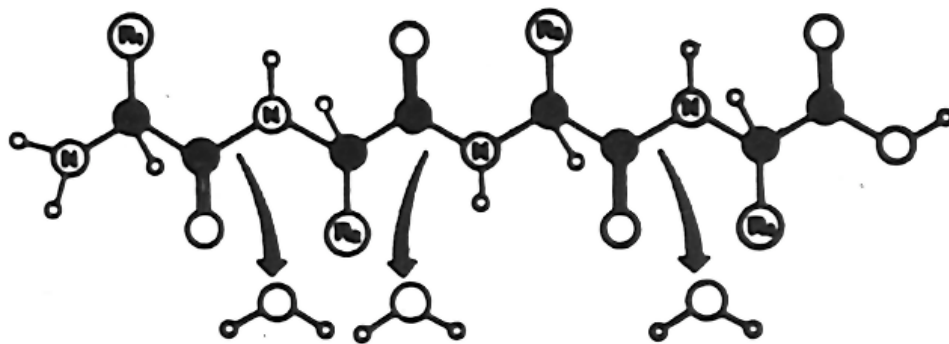

protein

A complex protein:

Involved in oxygen
use Each circle is an
amino acid

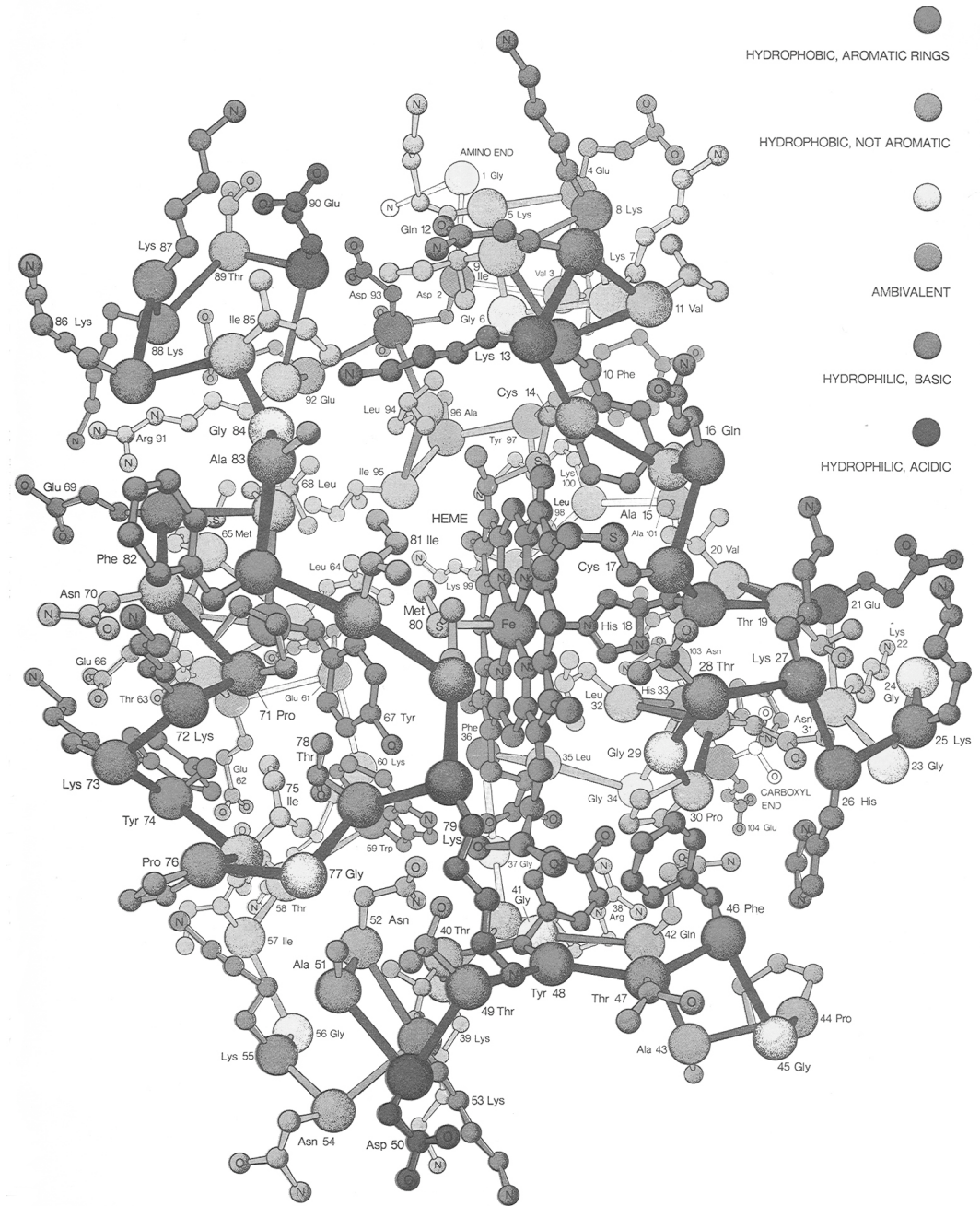

Stripped down view
Can you find the
amino end and the
carboxyl end?

Note the “heme”,
containing iron.

Function depends
on structure, which
depends on folding,
which depends on
order of amino acid
bases

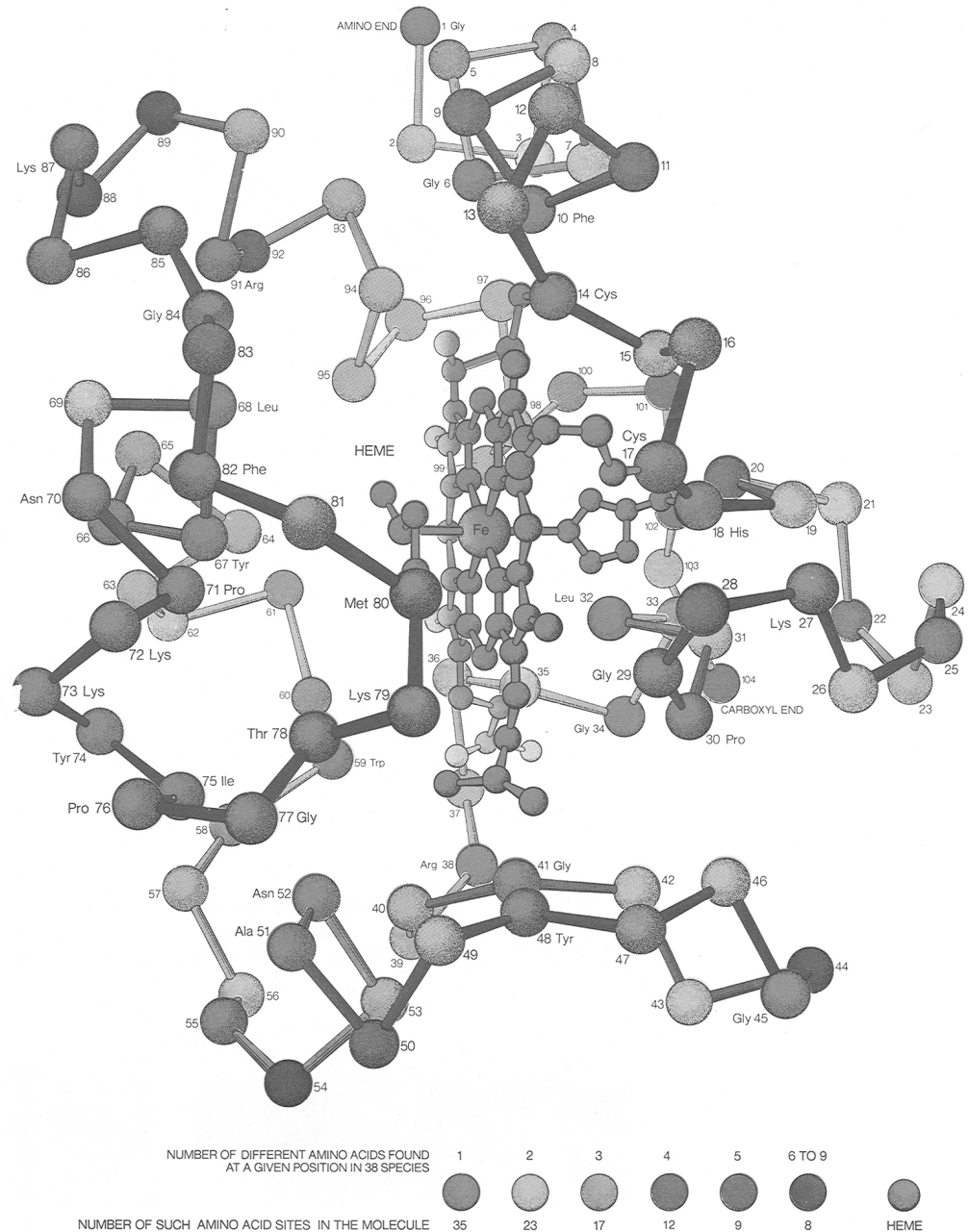

Nucleic Acids (DNA, RNA)

Made of sugars, phosphates, bases

Sugar

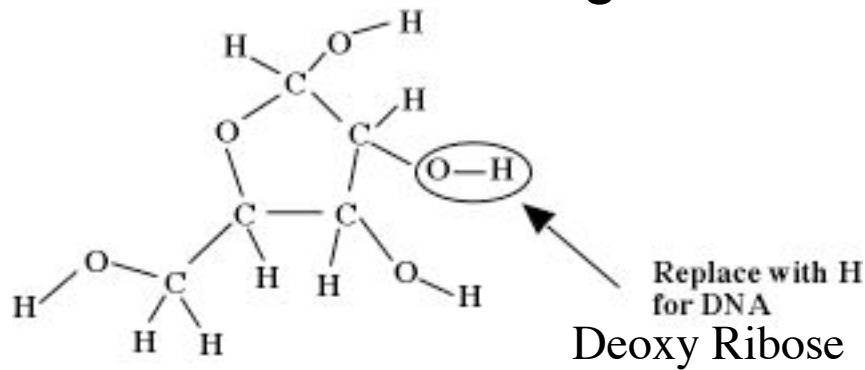

Schematic

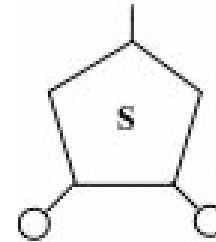

Ribose Sugar
5 C, 5 O, 10 H

Ribonucleic acid (RNA) uses ribose sugar;
Deoxyribonucleic acid (DNA) uses deoxyribose sugar

phosphate

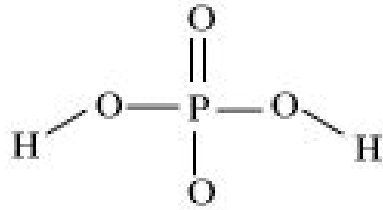

sugars & phosphates linked
phosphodiester bonds

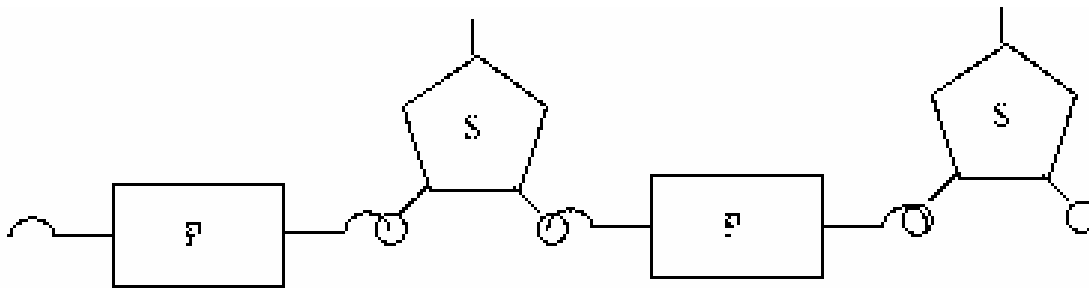

Segment of side of ladder structure

Nucleic Acids (cont.)

Bases: Carry Genetic Code

Purines

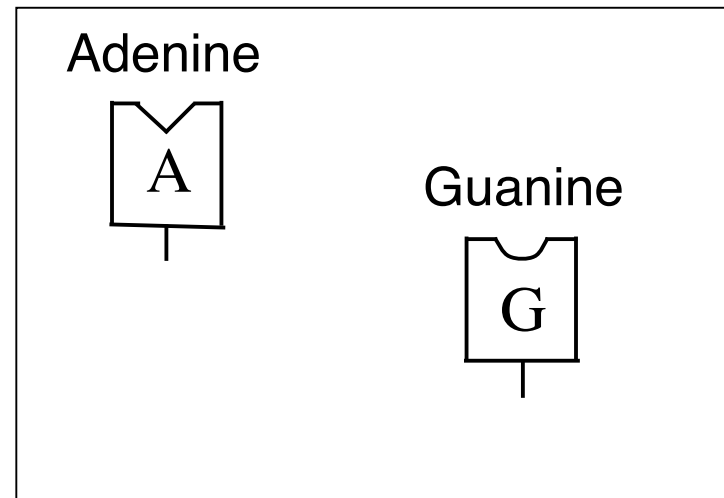
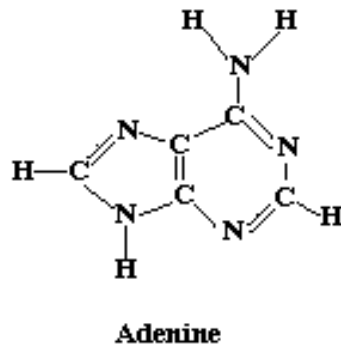

Equal numbers of C and N

Pyrimidines

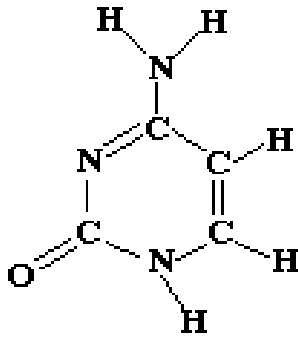

Cytosine

More C than N

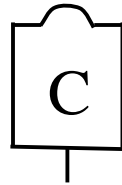

Cytosine

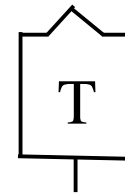

Uracil / Thymine

RNA / DNA

Bases in Nucleic acids: Purines and Pyrimidines

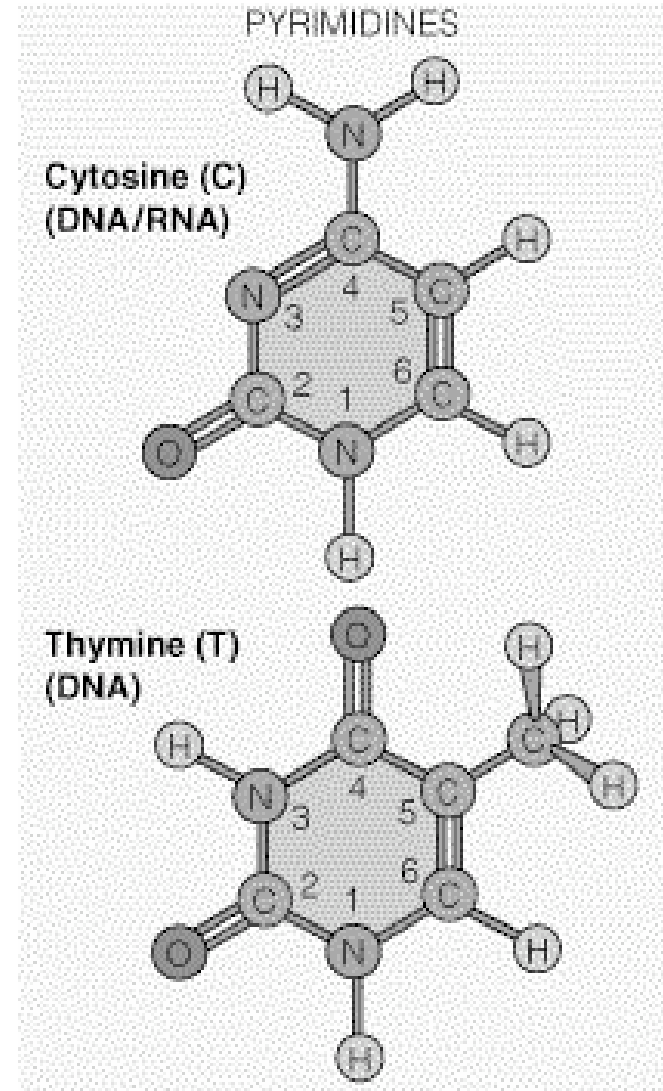
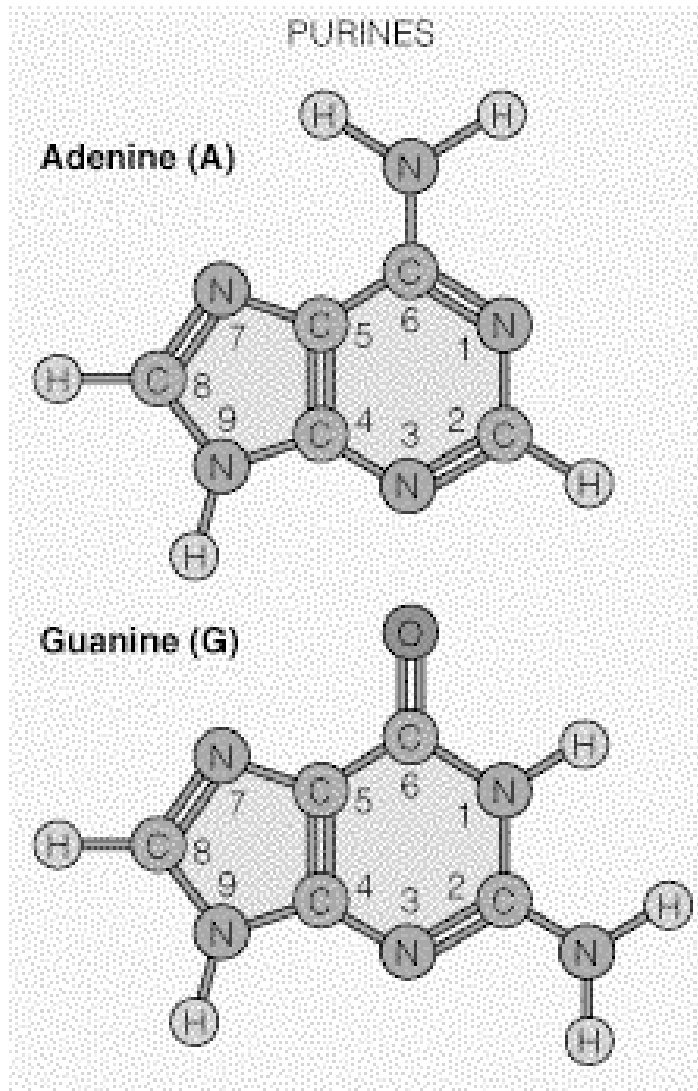

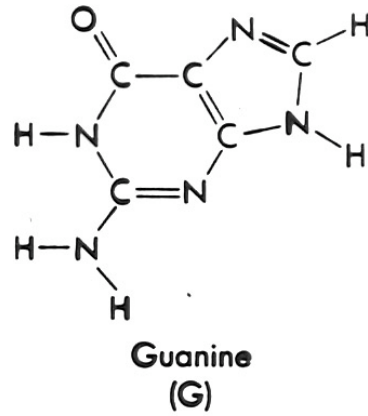
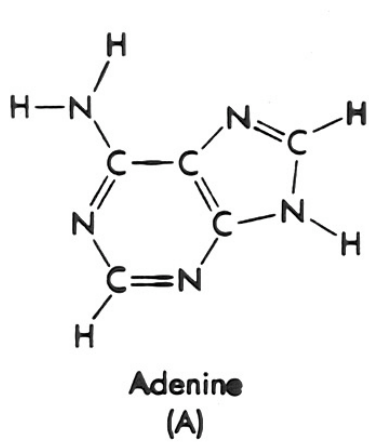

Purines

Pyrimidines

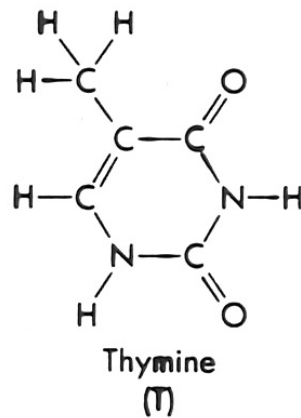
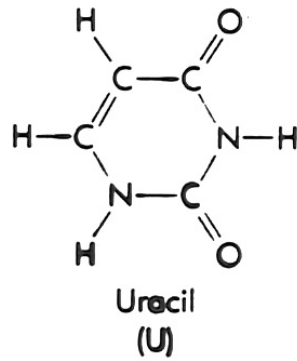
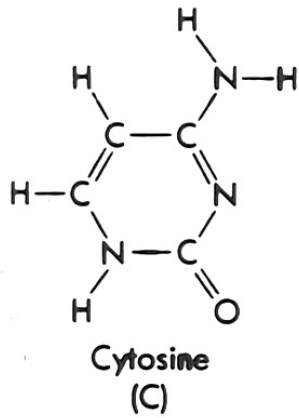

Pyrimidines

Note Uracil

Nucleic Acids (cont.)

Segment of RNA

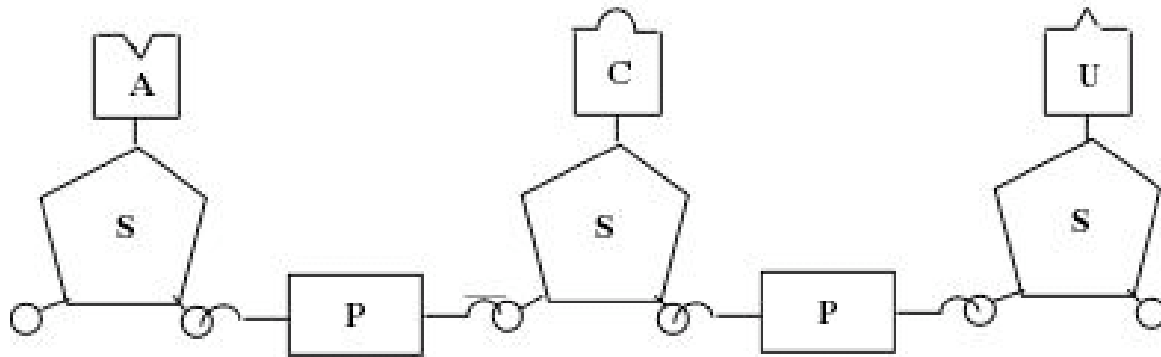

Segment of DNA

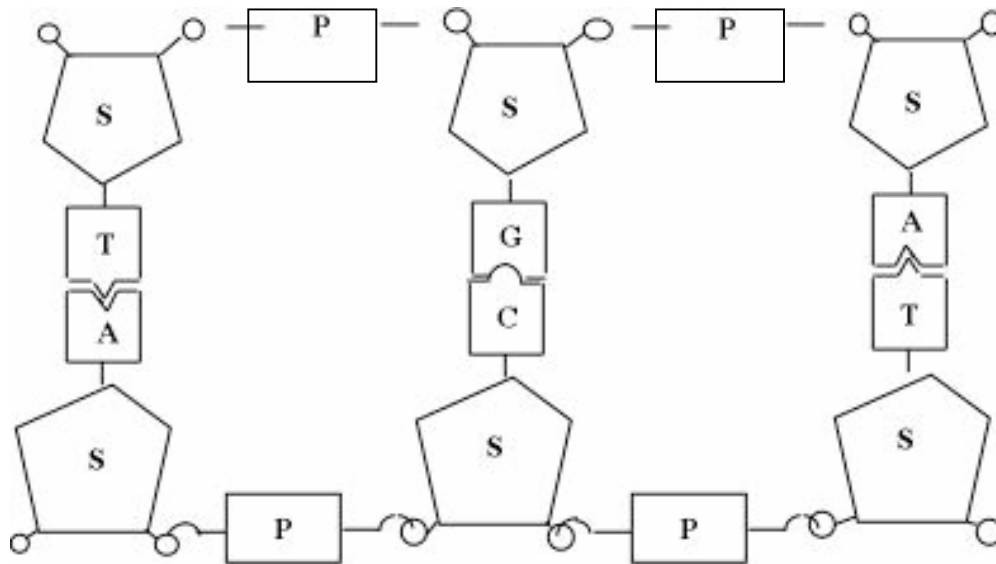

Note that T replaces U in DNA

At the Chemical Level

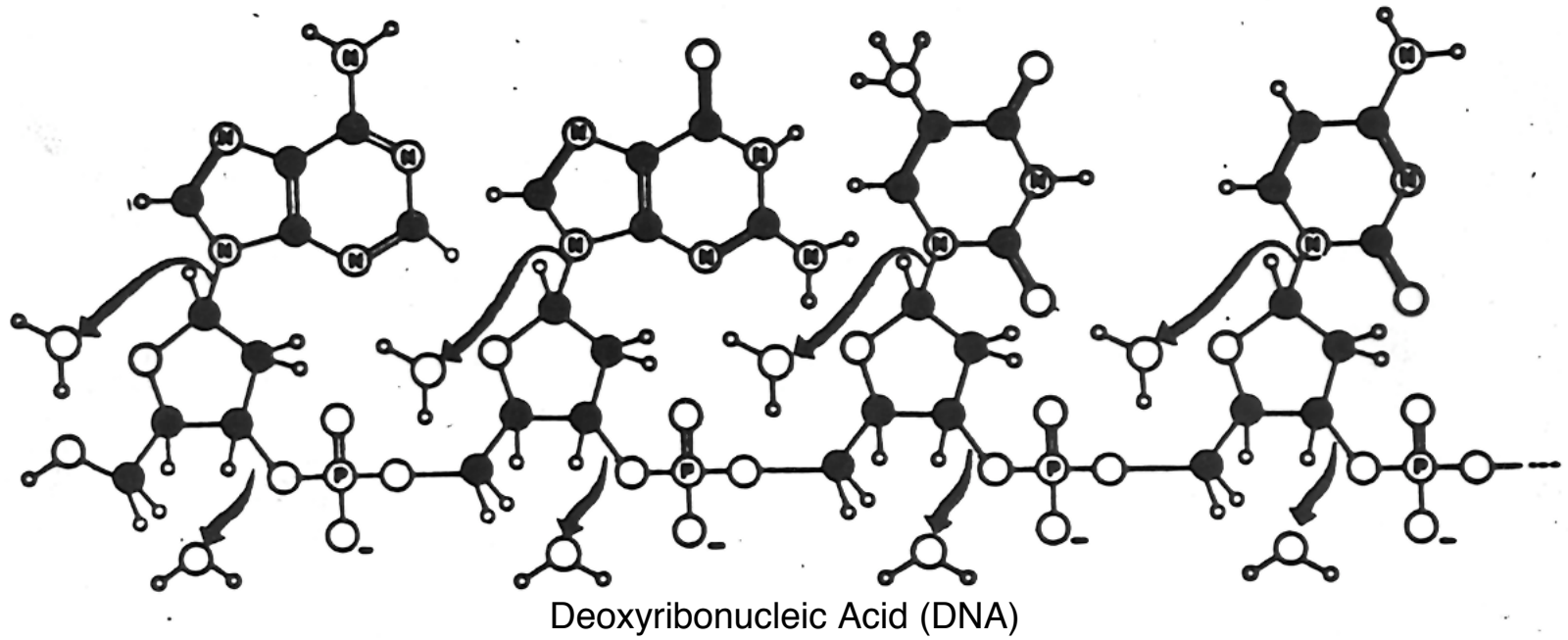
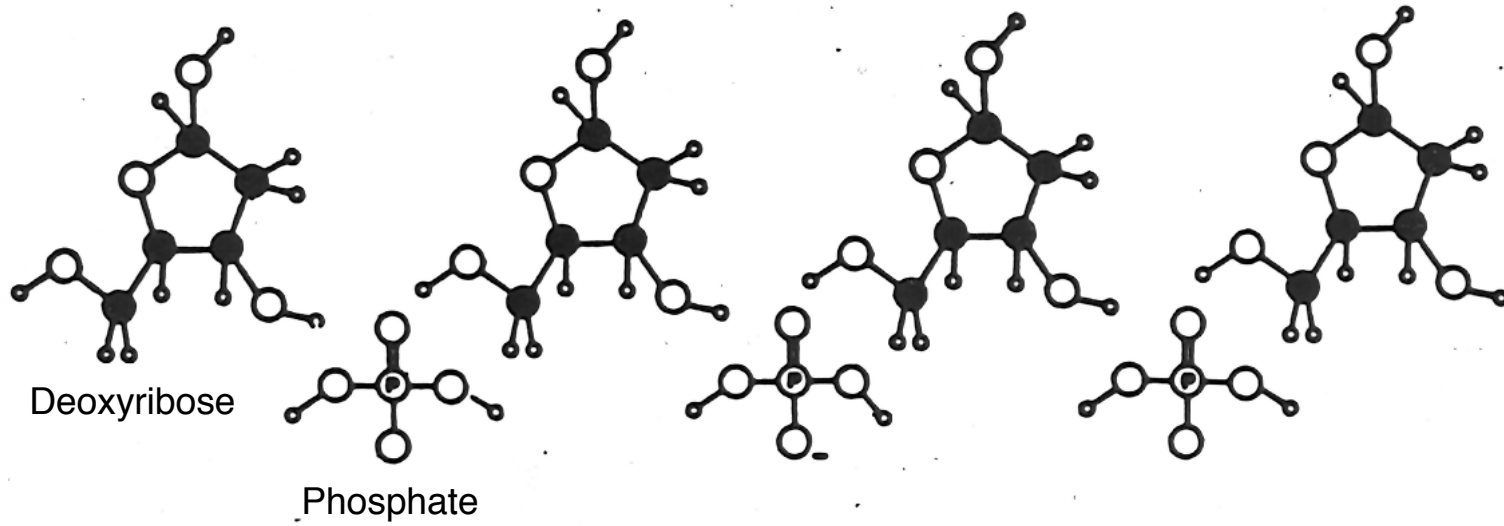

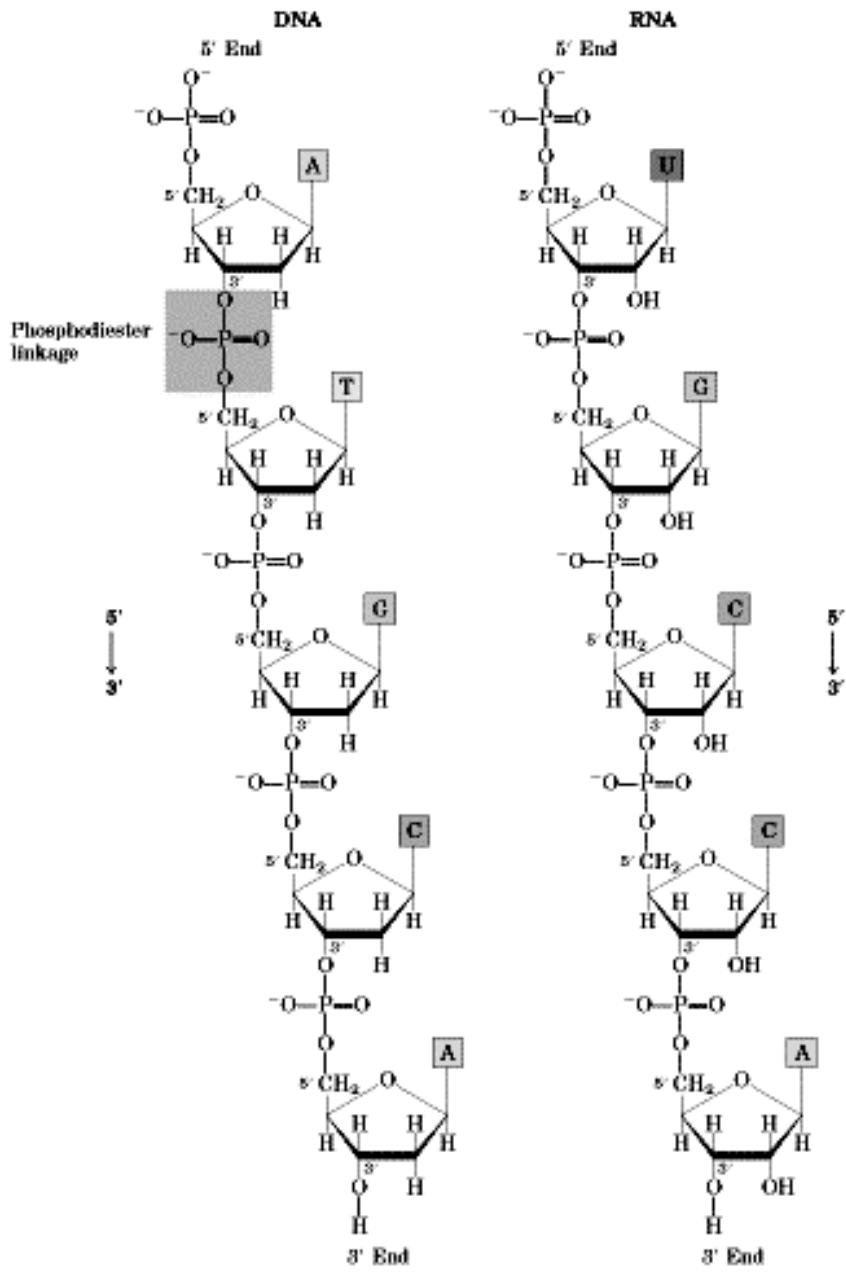

Hydrogen Bonds (weak) connect the bases across the two sides of DNA

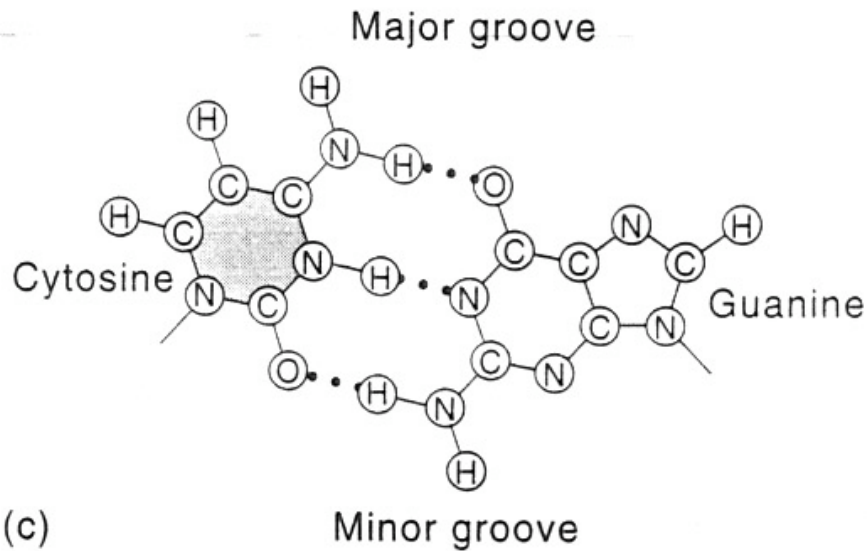
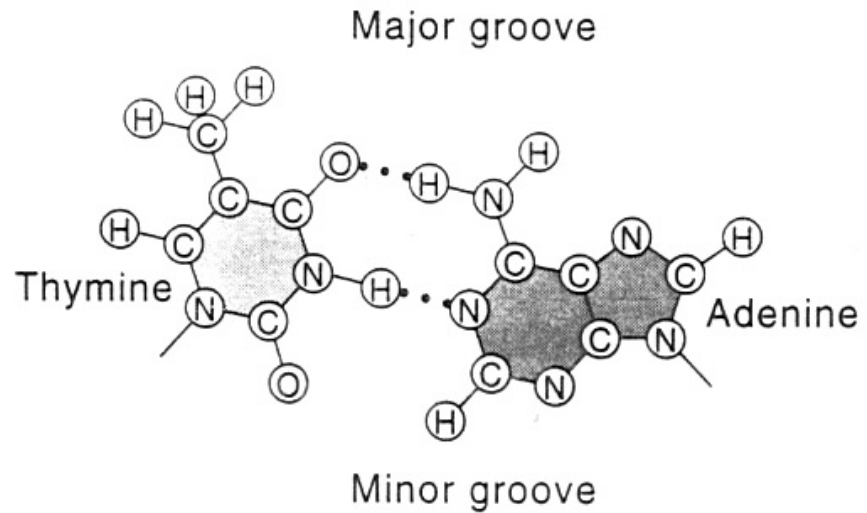

(c)

Segment of DNA

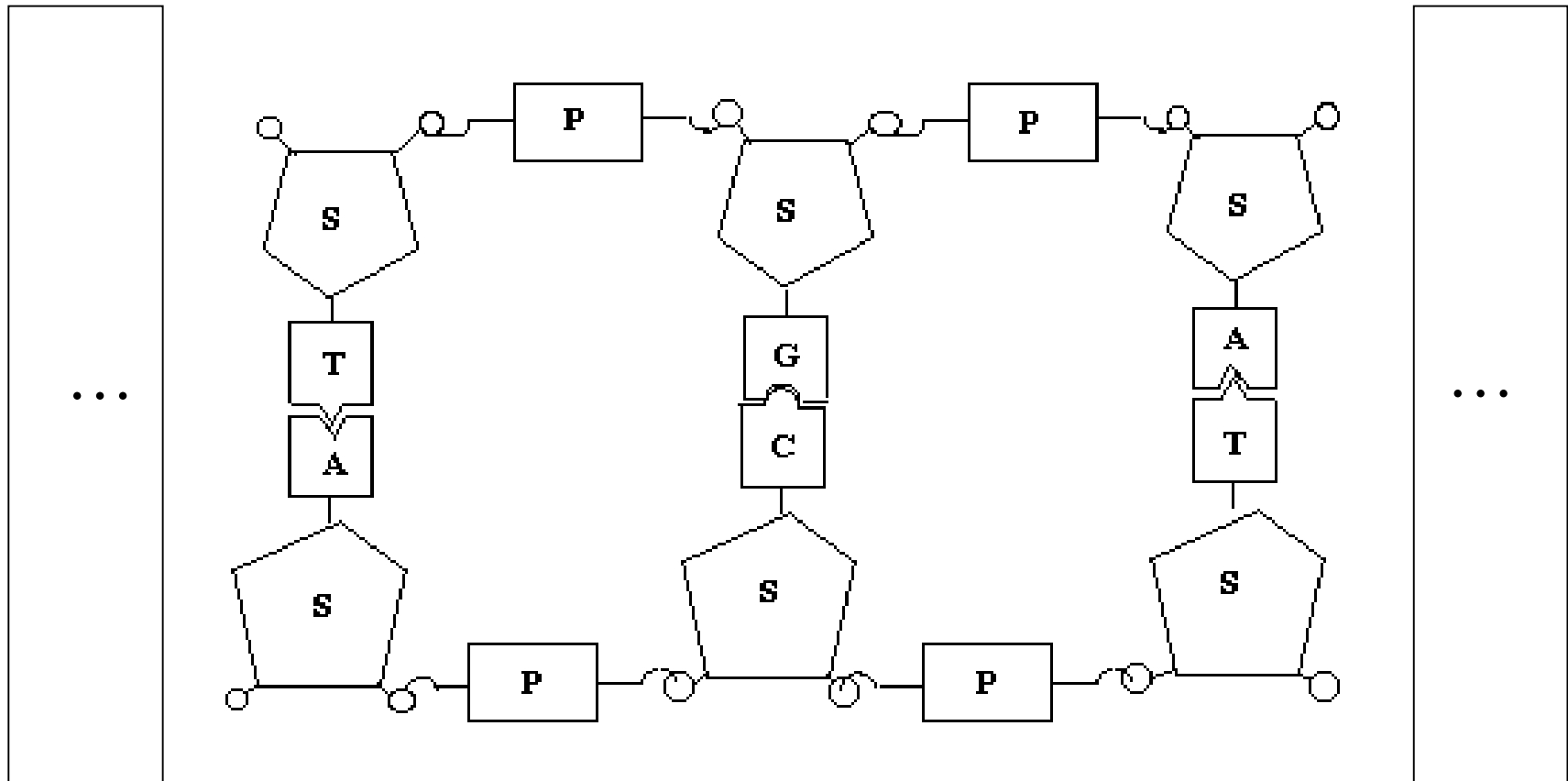

The two strands of DNA form a double helix, connected between bases by hydrogen bonds

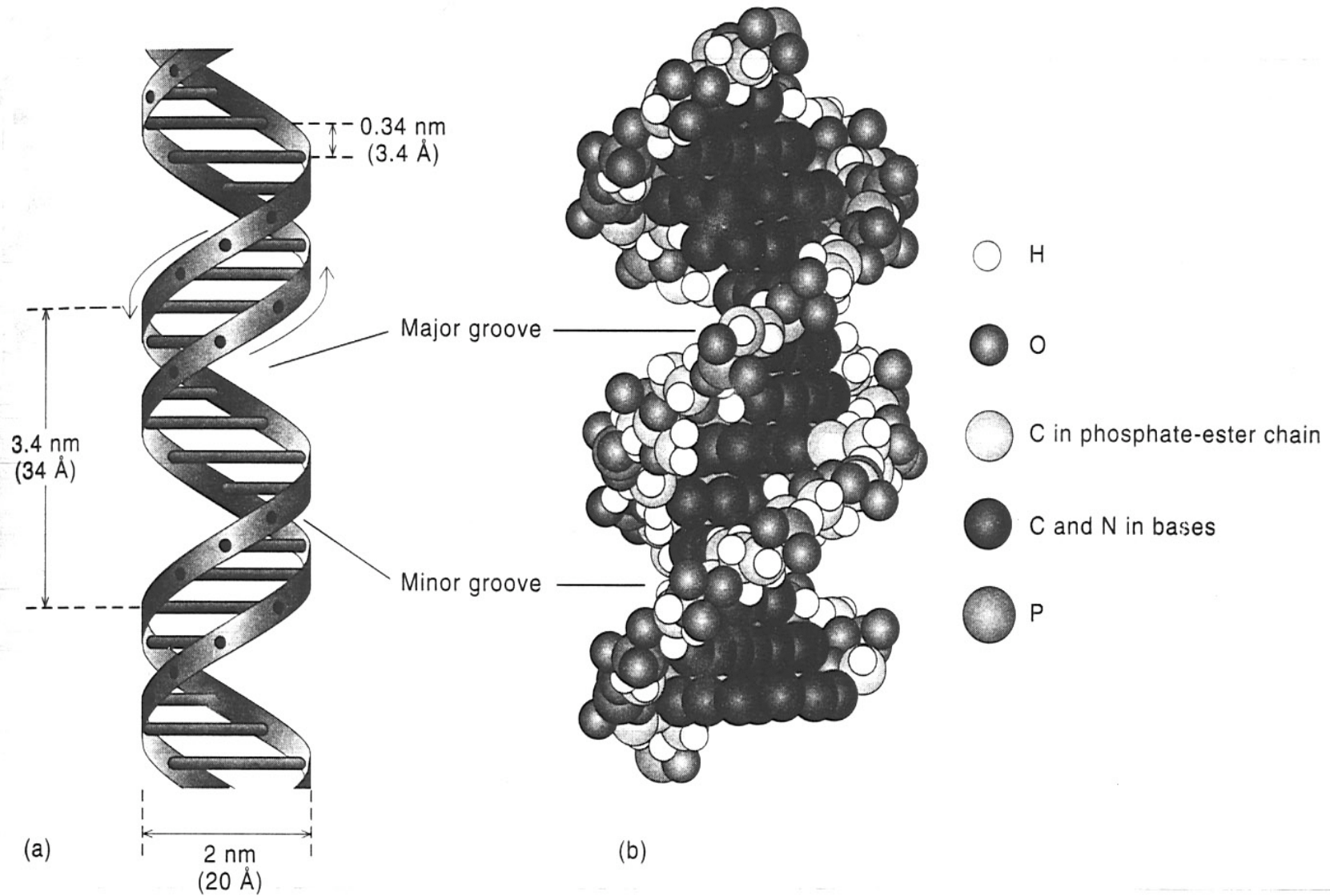

Further wrapping to make compact chromosome

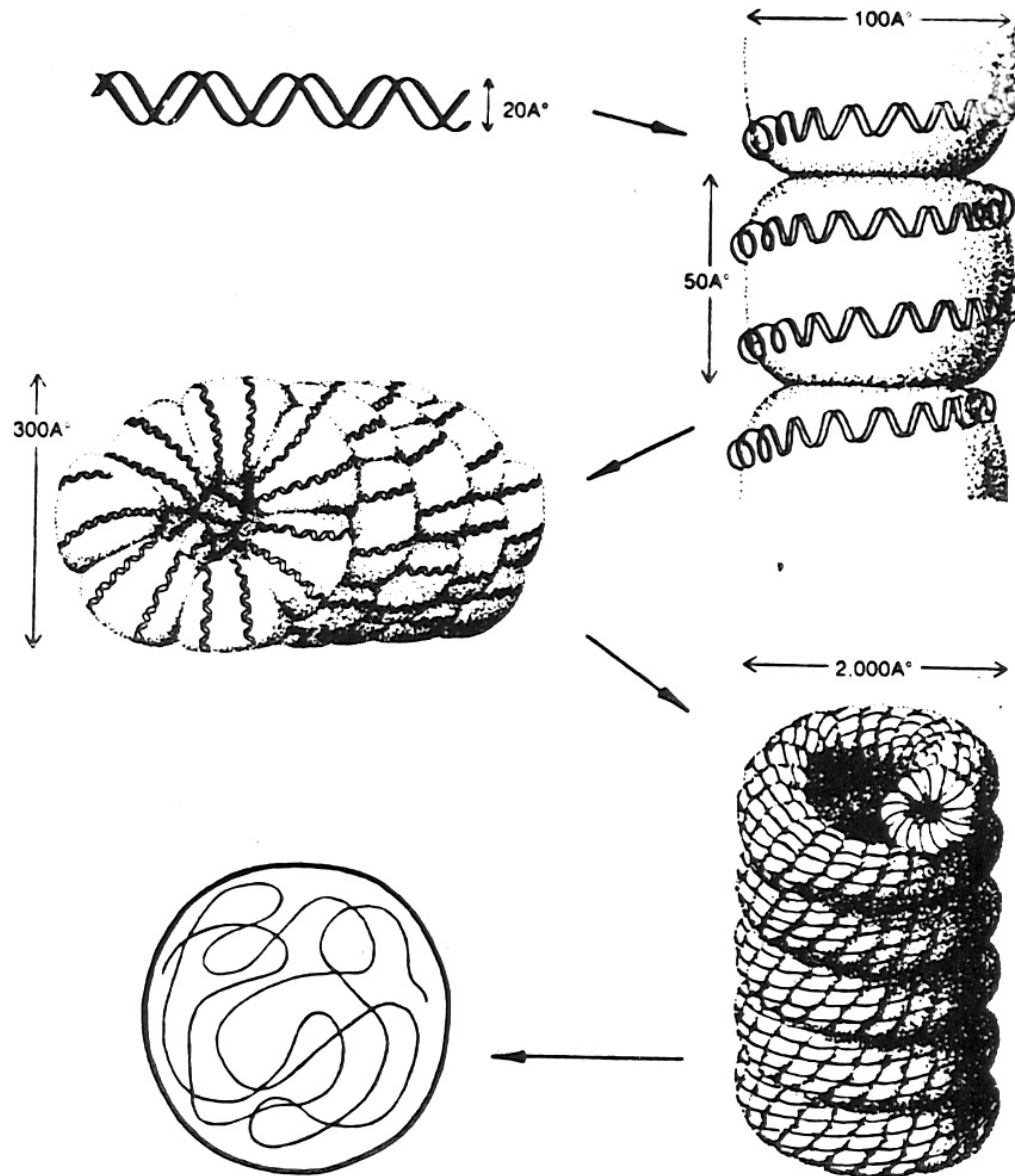

Information Storage

- Nucleic acids store information
- The information specifies proteins
- The information can be replicated
- This allows inheritance

Base pairing rules

A - T G - C
- U

⇒ Replication of order
(reproduction)

Nucleic Acid - Protein
↙ Genetic Code ↘

Codon

3 base sequence specifies an Amino Acid

Gene

Sequence of codons specifies a Protein

a gene specifies a protein

e.g.	tobacco mosaic virus	4 genes
	bacteria	$\sim 10^3$ genes
	human cell	$\sim 25,000$ genes (update)

For mRNA

Genetic Code

First RNA Base	U	C	A	G	Third RNA BASE
U	Phenylalanine	Serine	Tyrosine	Cysteine	U
	Phenylalanine	Serine	Tyrosine	Cysteine	C
	Leucine	Serine	Stop	Stop	A
	Leucine	Serine	Stop	Tryptophan	G
C	Leucine	Proline	Histidine	Arginine	U
	Leucine	Proline	Histidine	Arginine	C
	Leucine	Proline	Glutamine	Arginine	A
	Leucine	Proline	Glutamine	Arginine	G
A	Isoleucine	Threonine	Asparagine	Serine	U
	Isoleucine	Threonine	Asparagine	Serine	C
	Isoleucine	Threonine	Lysine	Arginine	A
	Start/Methionine	Threonine	Lysine	Arginine	G
G	Valine	Alanine	Aspartic Acid	Glycine	U
	Valine	Alanine	Aspartic Acid	Glycine	C
	Valine	Alanine	Glutamic Acid	Glycine	A
	Valine	Alanine	Glutamic Acid	Glycine	G

Amino Acids

PROTEIN SYNTHESIS

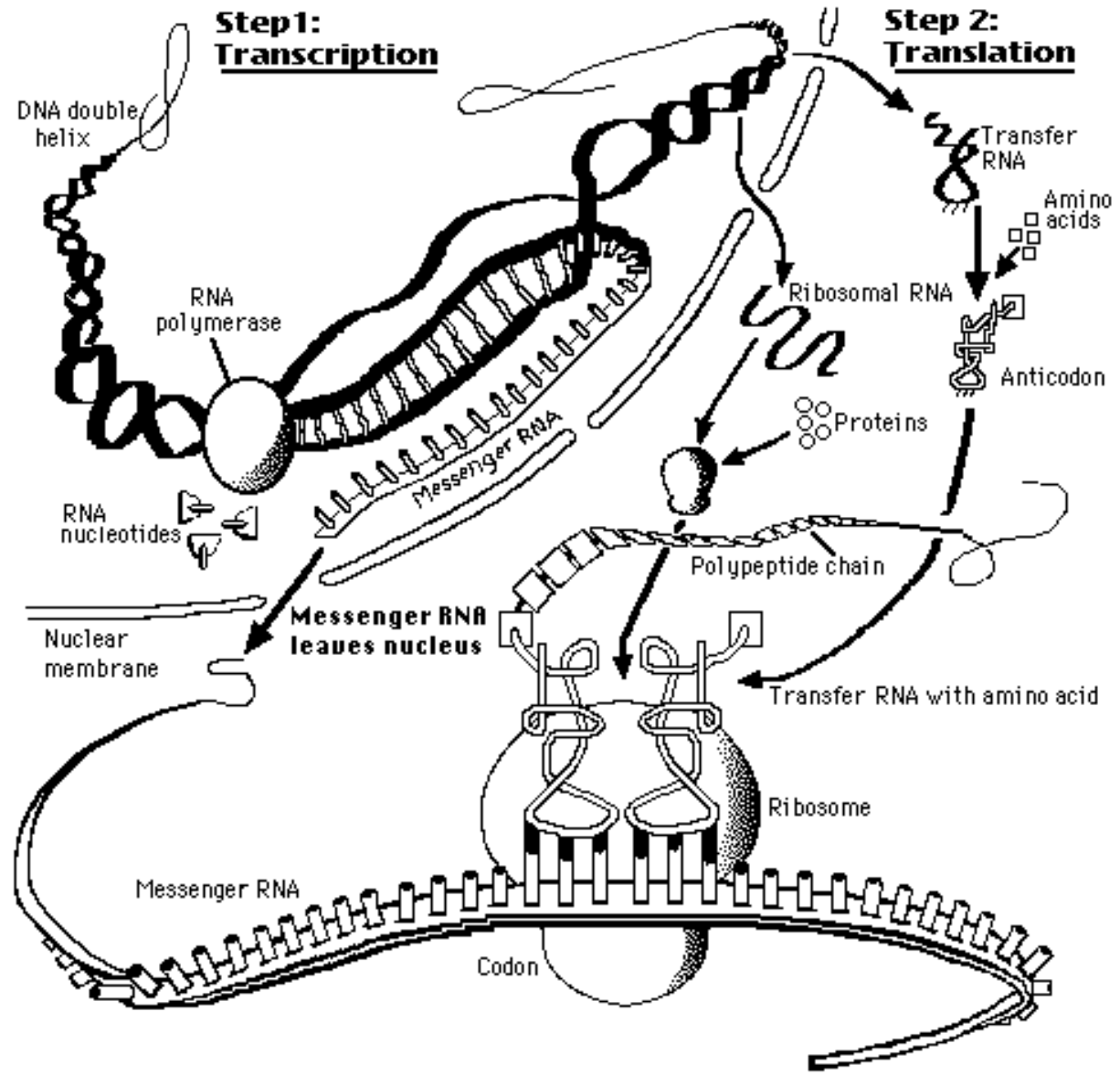

Structure of a tRNA

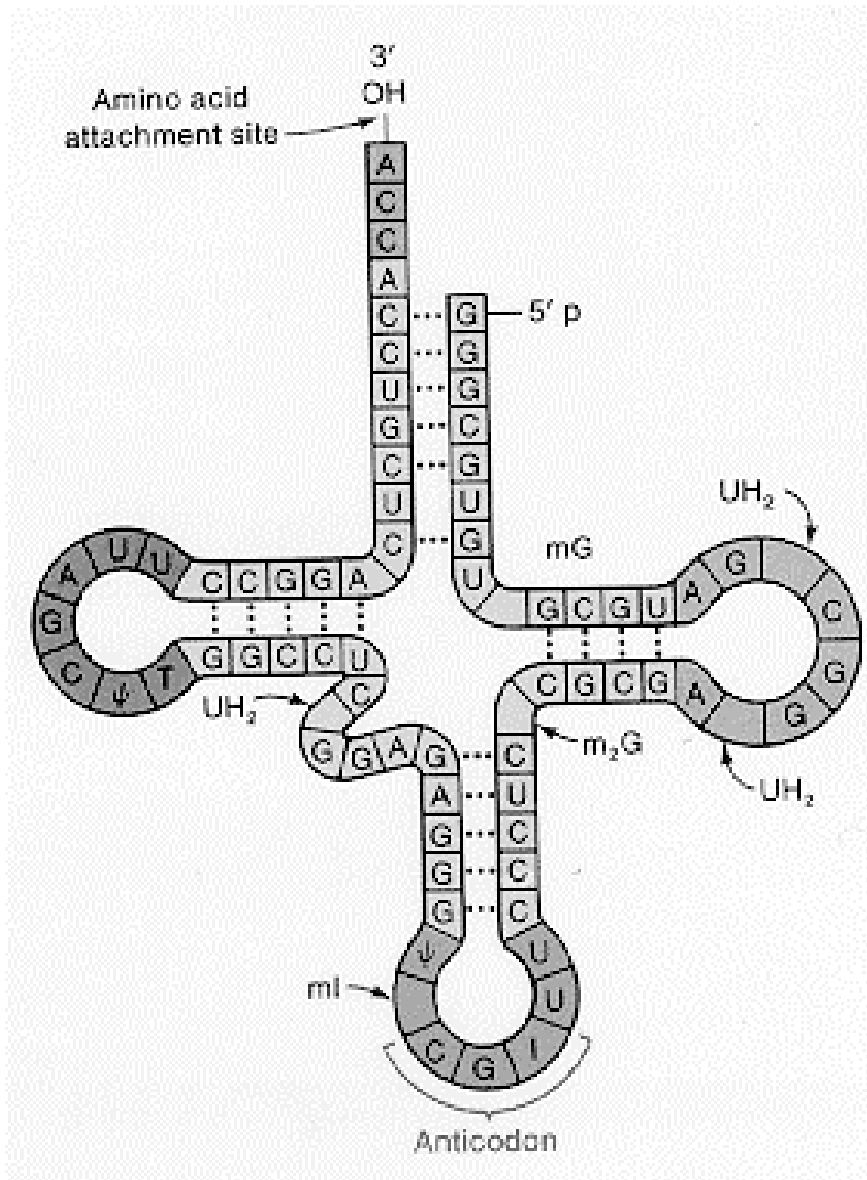

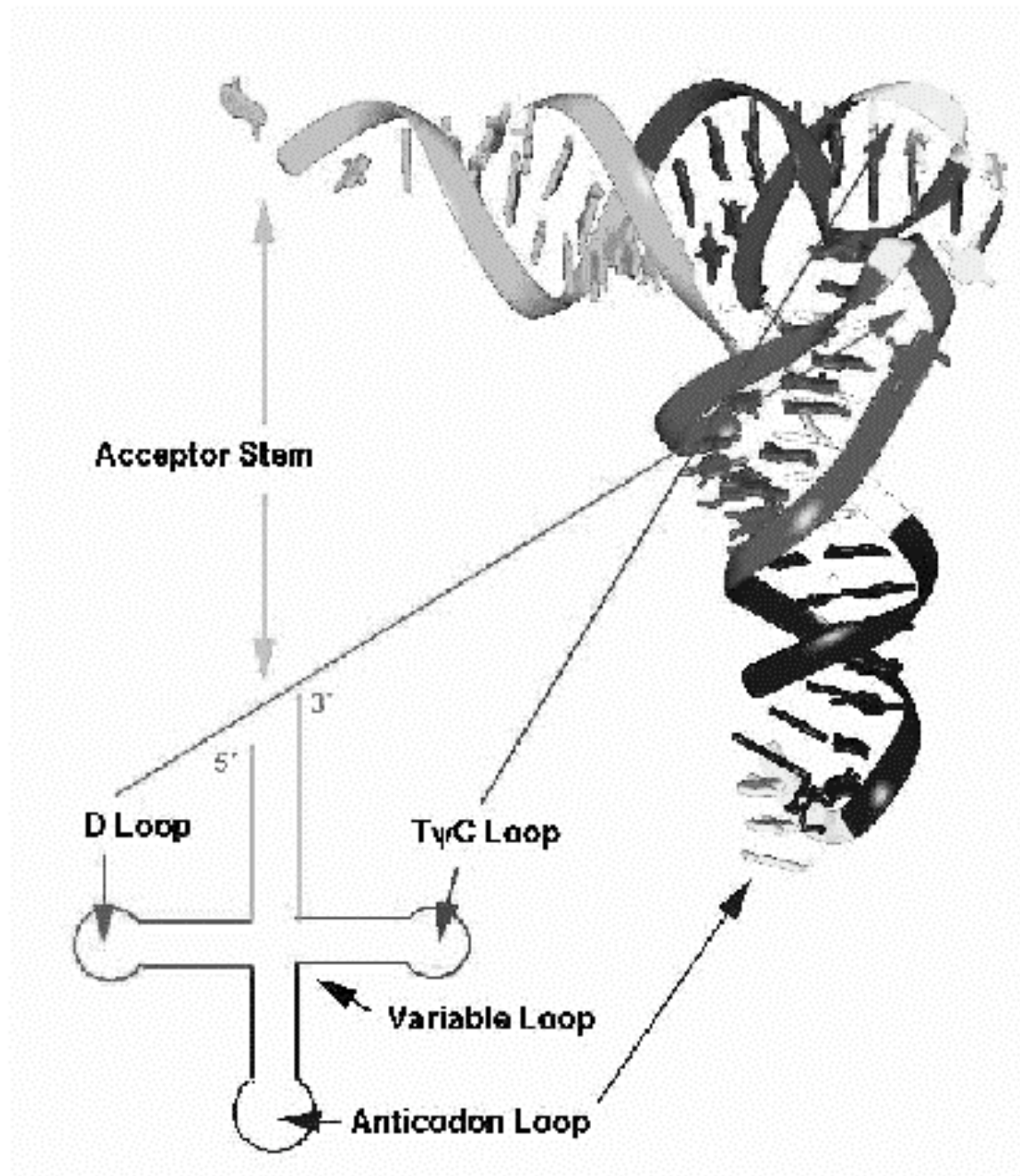

Translation

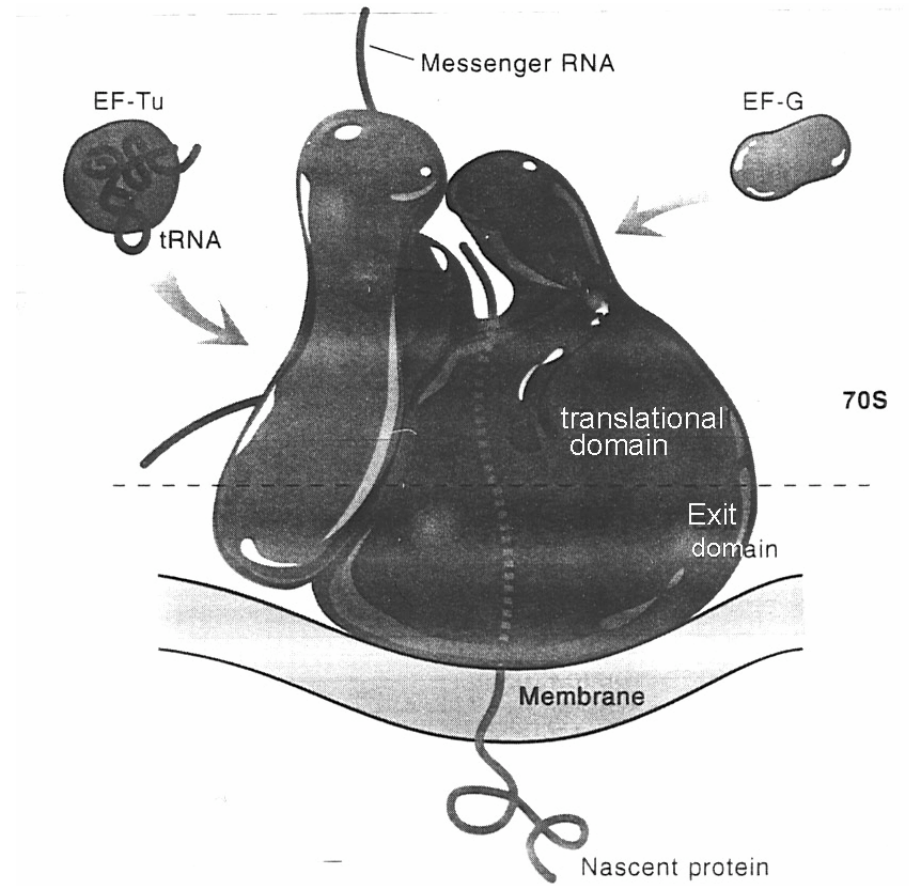
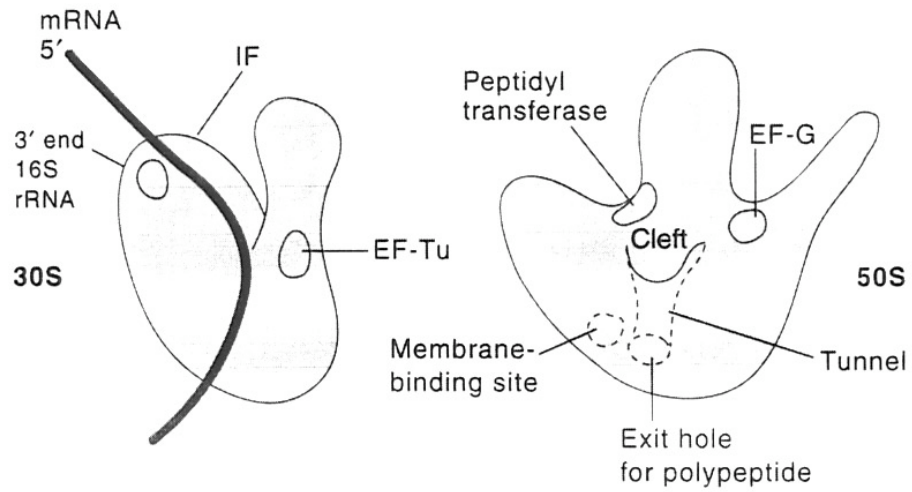

Variations in the Code

1. “Wobble” Bases

The third base in a codon can sometimes vary.

tRNA

U

G

mRNA

A or G

C or U

Comparison to genetic code \Rightarrow no change
in amino acids

For mRNA

Genetic Code

First RNA Base	U	C	A	G	Third RNA BASE
U	Phenylalanine	Serine	Tyrosine	Cysteine	U
	Phenylalanine	Serine	Tyrosine	Cysteine	C
	Leucine	Serine	Stop	Stop	A
	Leucine	Serine	Stop	Tryptophan	G
C	Leucine	Proline	Histidine	Arginine	U
	Leucine	Proline	Histidine	Arginine	C
	Leucine	Proline	Glutamine	Arginine	A
	Leucine	Proline	Glutamine	Arginine	G
A	Isoleucine	Threonine	Asparagine	Serine	U
	Isoleucine	Threonine	Asparagine	Serine	C
	Isoleucine	Threonine	Lysine	Arginine	A
	Start/Methionine	Threonine	Lysine	Arginine	G
G	Valine	Alanine	Aspartic Acid	Glycine	U
	Valine	Alanine	Aspartic Acid	Glycine	C
	Valine	Alanine	Glutamic Acid	Glycine	A
	Valine	Alanine	Glutamic Acid	Glycine	G

Amino Acids

2. Some organisms use slightly different codes, with one or more changes in codon translation.

First seen in mitochondrial DNA.

Now known in some nuclear DNA

The code has evolved since the last common ancestor (But not much).

Summary

1. Atoms needed: H, C, O, N, small amounts of P (phosphorus), S (sulfur)
2. Two basic molecules needed for life: proteins, nucleic acids
3. Both are polymers - made of simpler monomers. The monomers function as words or letters of alphabet. Information is the key.

Summary (cont.)

4. Proteins and nucleic acids closely linked at fundamental level. Communicate through genetic code. All organisms have almost the same genetic code. It must have originated very early in evolution of life.
5. In present day organisms, protein synthesis must be directed by nucleic acids, but nucleic acid reading or replication requires enzymes (proteins). Chicken-Egg problem

Some Movies of Processes

- Animation of transcription (making mRNA)
 - <http://vcell.ndsu.nodak.edu/animations/transcription/movie.htm>
- Animation of translation (making protein)
 - <http://vcell.ndsu.nodak.edu/animations/translation/movie.htm>
- Both from Virtual Cell Animation collection,
Molecular and Cellular Biology Learning
Center