

Planet Detection

Estimating f_p

Can We See Them?

- Not yet, but there are plans...
 - 3 recent claims, but planets very far from star, so some doubts
- Problem is separating planet light from star light
 - Star is 10^9 times brighter in visible light
 - “Only” 10^6 times brighter in infrared

Planet is Much Fainter than Star

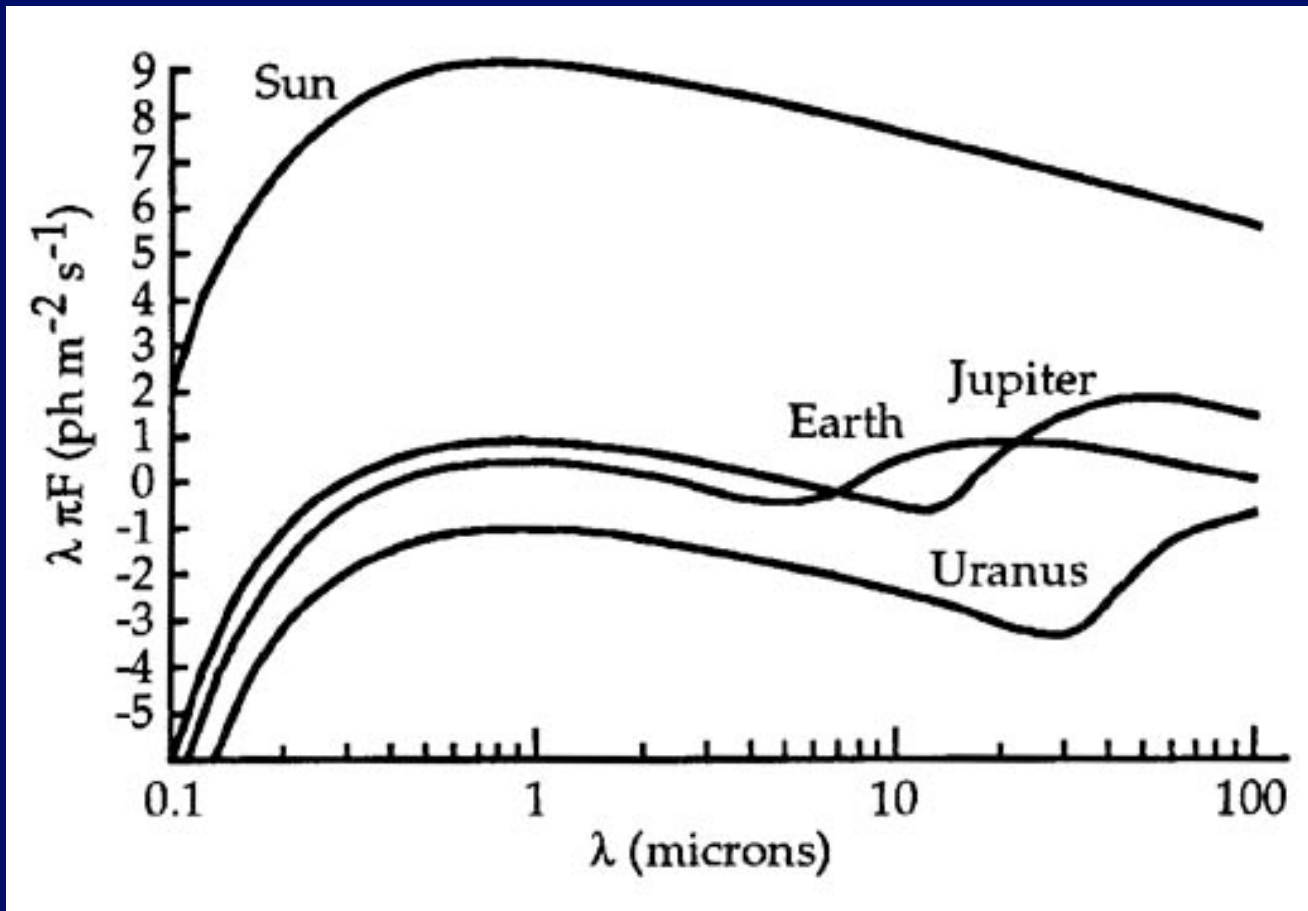

Indirect Detection

Wobbling star

Detect effect of planet on star (both orbit around center of mass)

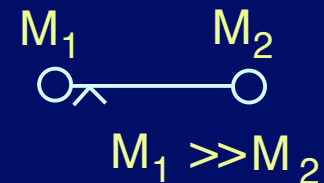
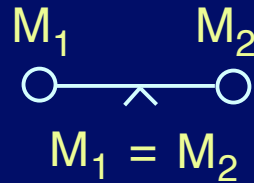

Large planet will make a star “wobble”

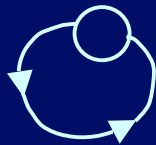

In plane of sky observe
position shift



Along our line of
sight

Observe Doppler
Shift

Star and Planet Orbit Center of Mass

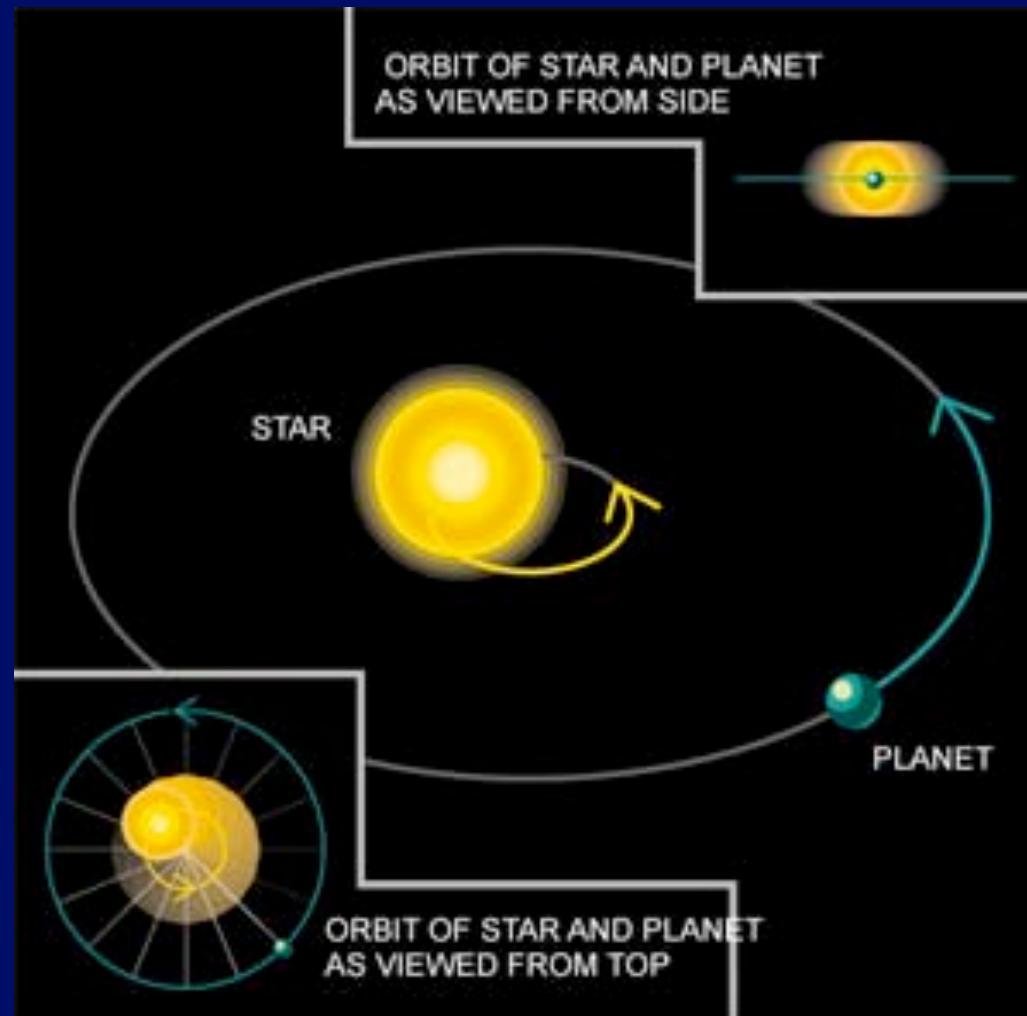

The Astrometric Technique

Measure stellar position (angle) accurately - see wobble compared to more distant stars

How far does the star wobble?

Center of mass

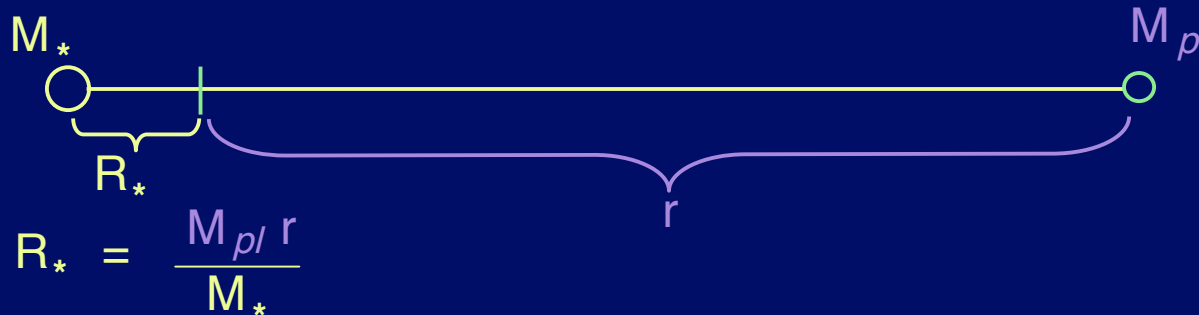

We measure angle; for small angles,

$$\Theta = \frac{R_*}{D} \quad \text{in radians}$$



so
$$\Theta = \frac{M_{pl} r}{M_*} \frac{1}{D}$$
 Big planet, big orbit
small star, close to sun

Current limit: 1 mas = 10^{-3} arcsec = 2.8×10^{-6} degrees
= 4.9×10^{-8} radians

e.g. $M_{pl} = M_{Jupiter}$, $M_* = M_{\odot}$, $D = 15 \text{ ly} \Rightarrow \Theta = 1 \text{ mas}$

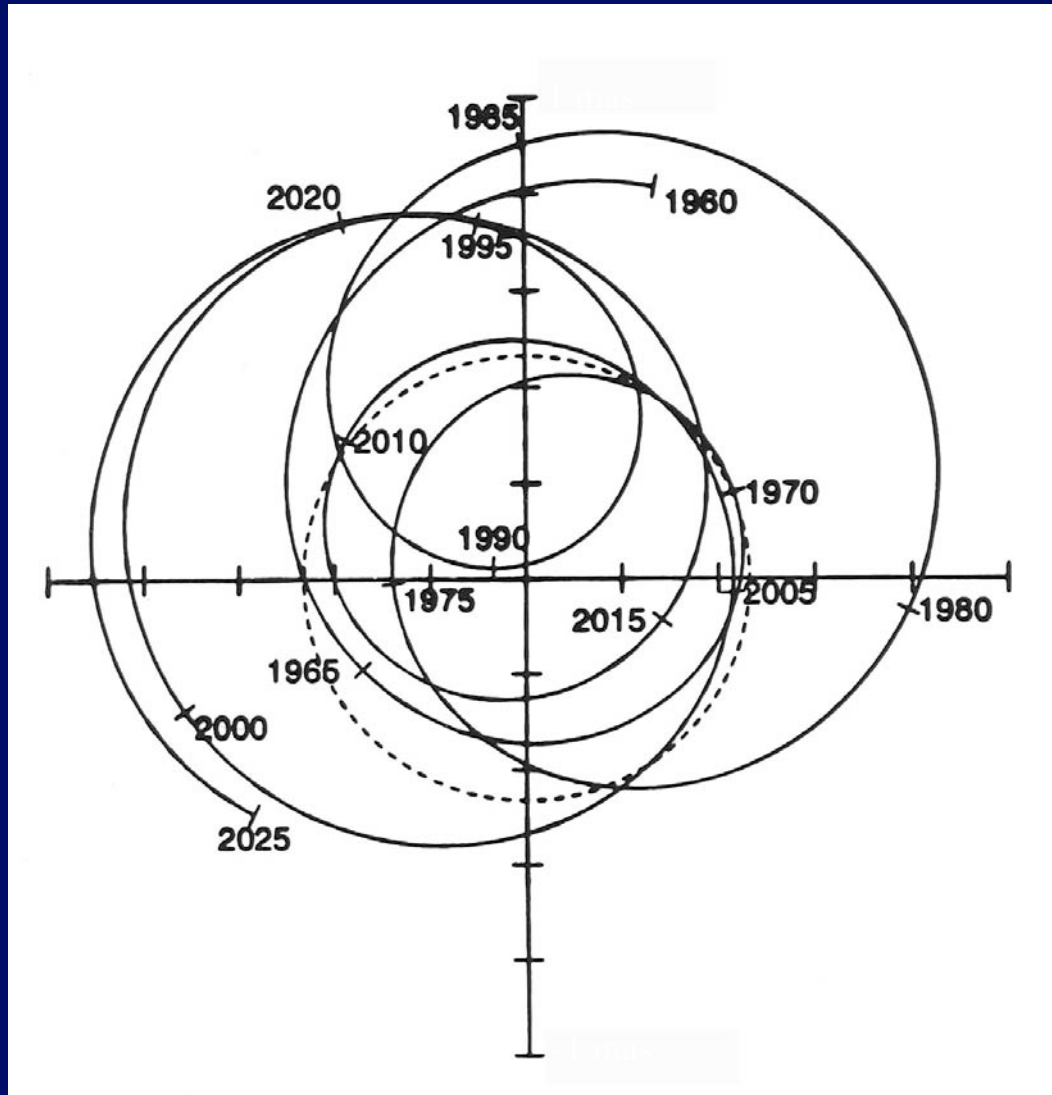

The Sun as viewed from 10 pc (~ 30 ly)

30 ly

Planet	M_p (M_J)	R (AU)	P (years)	V_\star ($m s^{-1}$)	Θ at 10 pc (mas)
Mercury	1.74E-4	0.387	0.241	0.008	6.4E-6
Venus	2.56E-3	0.723	0.615	0.086	1.8E-4
Earth	3.15E-3	1.000	1.000	0.089	3.0E-4
Mars	3.38E-4	1.524	1.881	0.008	4.9E-5
Jupiter	1.0	5.203	11.86	12.4	0.497
Saturn	0.299	9.54	29.46	2.75	0.273
Uranus	0.046	19.18	84.01	0.297	0.084
Neptune	0.054	30.06	164.8	0.281	0.156
Pluto	6.3E-6	39.44	247.7	3E-5	2.4E-5

The Spectroscopic Method

- Relies on Doppler Effect
- Motion of star towards and away from us
- Almost all planets around other stars found by this method so far

The Doppler Shift

Light is a wave

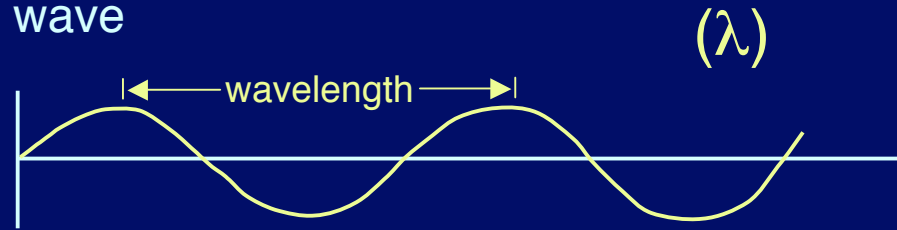

moving star

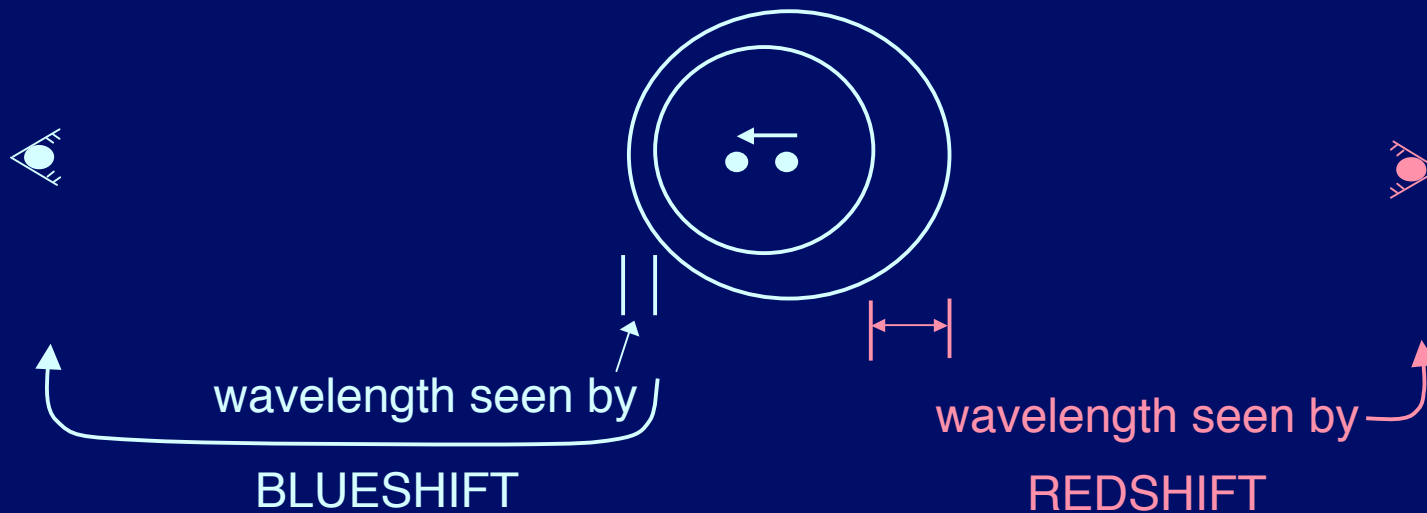

$$\frac{\lambda_{\text{observed}}}{\lambda_{\text{emitted}}} = 1 + \frac{v}{c}$$

Doppler Shift \longrightarrow Magnitude and direction of velocity

But only along line-of-sight

The Spectroscopic Technique

Measure velocity, not position, of star

Use spectrometer to get Doppler Shift of spectral line

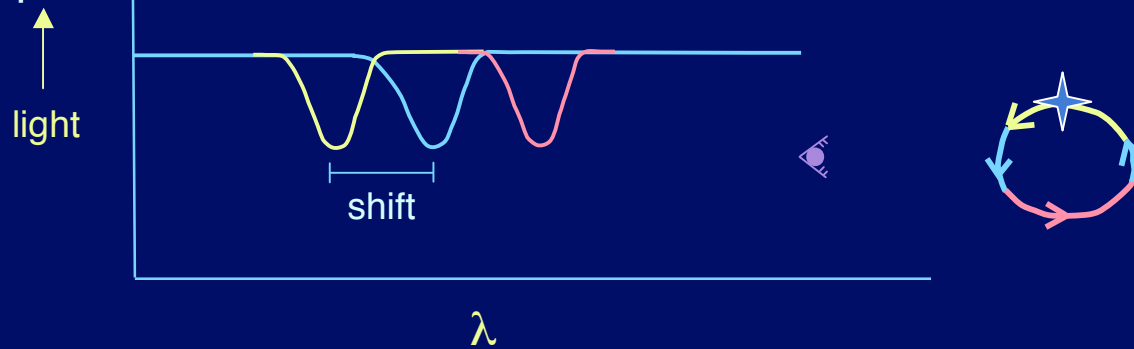

$$\text{Shift} \propto V_* \propto \frac{M_{pl}}{M_*^{1/2} r^{1/2}}$$

Big planet, small orbit

Small star

Distance doesn't matter (except for brightness)

Edge - On

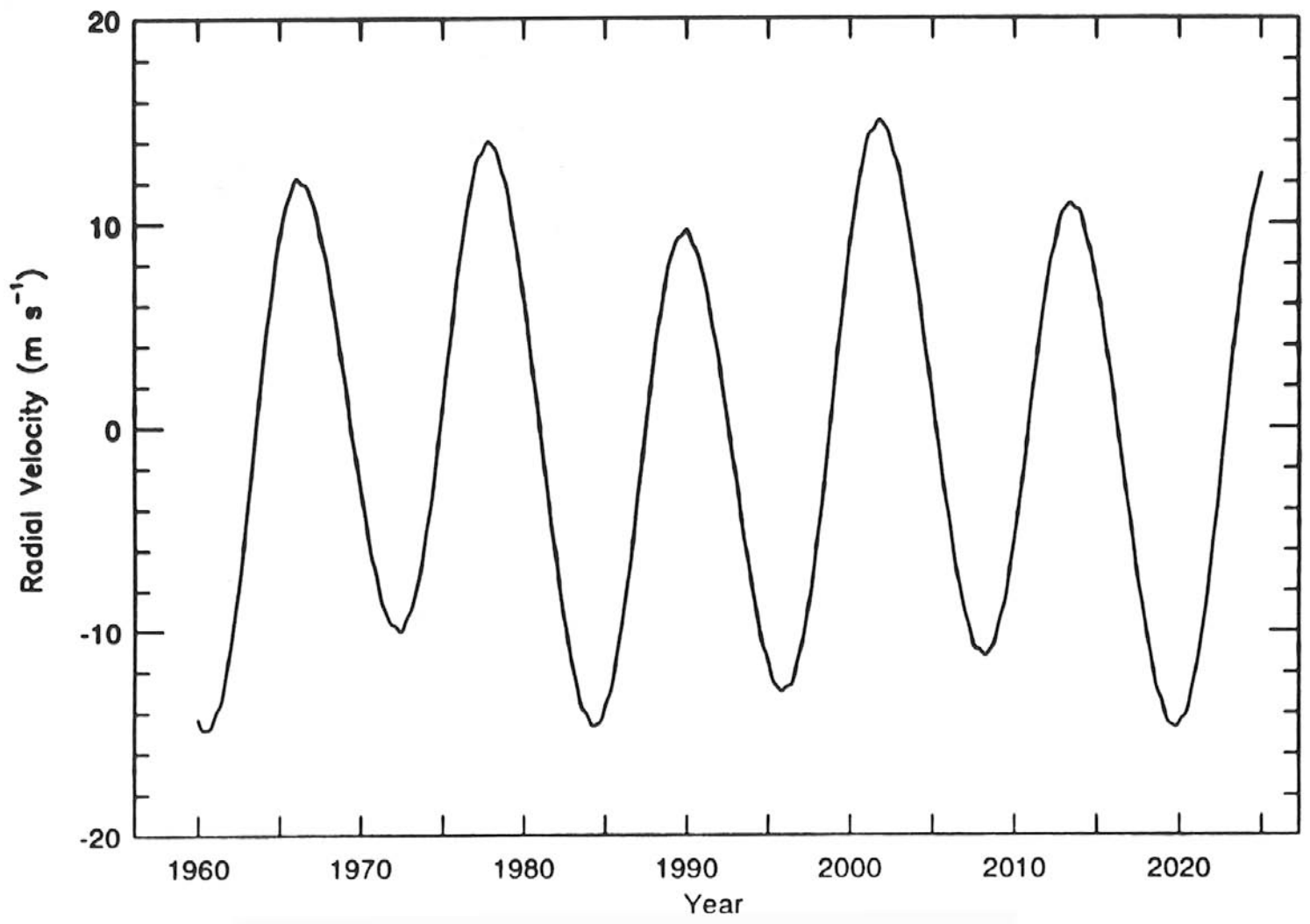

Motion of the Sun caused by Jupiter, ...

30 ly

Planet	M_p (M_J)	R (AU)	P (years)	V_\star ($m s^{-1}$)	Θ at 10 pc (mas)
Mercury	1.74E-4	0.387	0.241	0.008	6.4E-6
Venus	2.56E-3	0.723	0.615	0.086	1.8E-4
Earth	3.15E-3	1.000	1.000	0.089	3.0E-4
Mars	3.38E-4	1.524	1.881	0.008	4.9E-5
Jupiter	1.0	5.203	11.86	12.4	0.497
Saturn	0.299	9.54	29.46	2.75	0.273
Uranus	0.046	19.18	84.01	0.297	0.084
Neptune	0.054	30.06	164.8	0.281	0.156
Pluto	6.3E-6	39.44	247.7	3E-5	2.4E-5

What We Can Learn

1. There is a planet
(If not a mistake)
2. The orbital period (P)
(The time for pattern to repeat)
3. The orbital radius

$$r^3 \propto M_* P^2$$

(Kepler's Third Law)

4. Lower limit to planet mass (M_{planet})

Conservation of momentum \longrightarrow

$$M_{pl} \geq \frac{M_* V_* P}{2\pi r}$$

= if we see orbit edge-on

> if tilted

Comparison of Search Methods

Advantages

Astrometric

Big Planet

Big Orbit

Small Star

Nearby Star

Spectroscopic

Big Planet

Small Orbit

Small Star

--

Edge-on Orbit

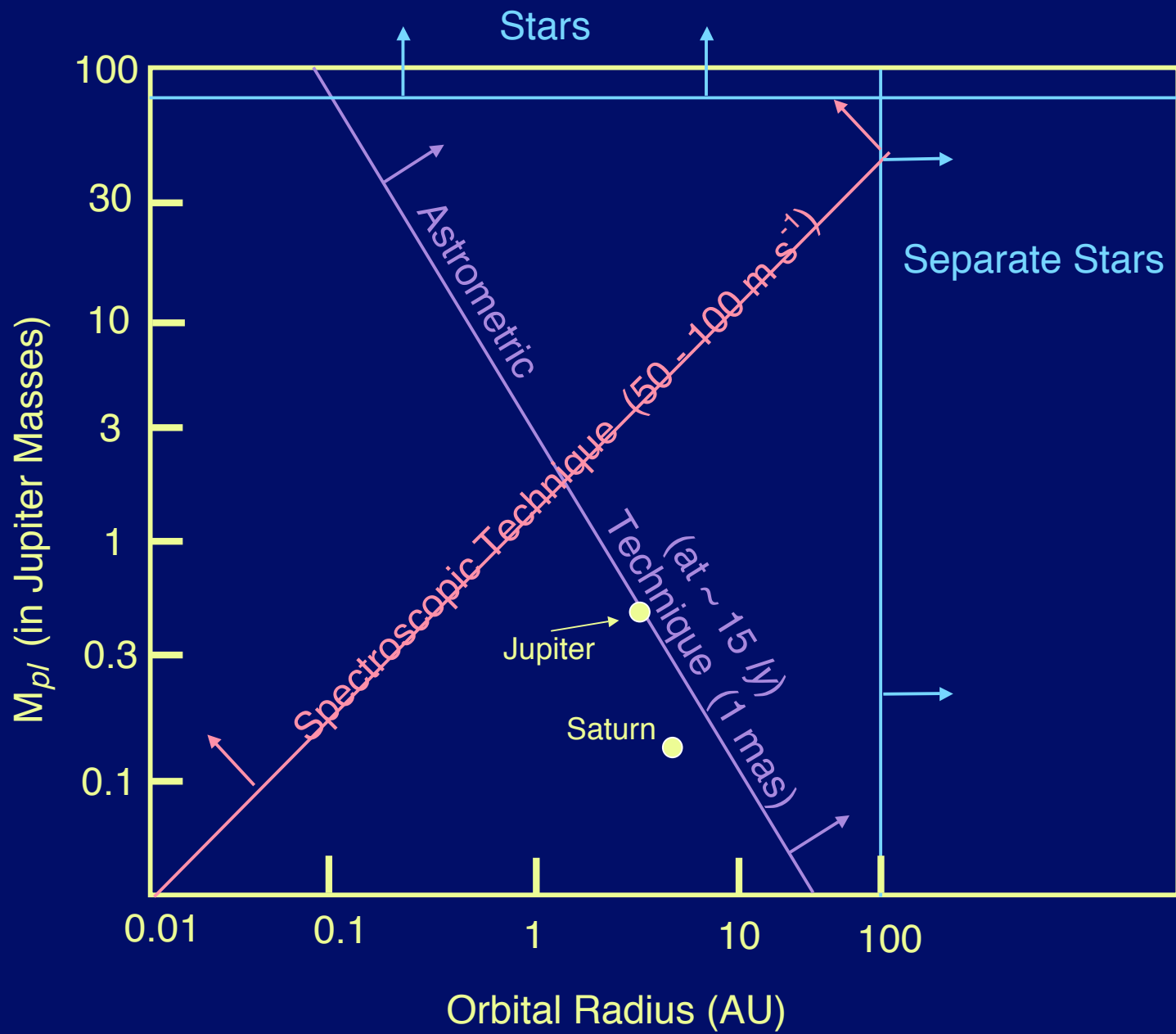

Other Methods

Transits: Planet passes in front of a star



US

Only about 0.5% of stars with planets will line up

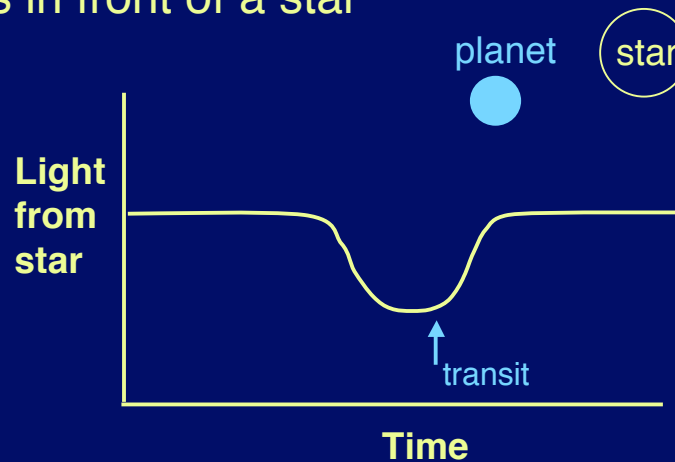

First planet found with this method in January 2003; 9 detected as of January 2006

Microlensing: Light from more distant star is focused by gravity of nearer star passing in front



Fortuitous alignment \Rightarrow brightens

Three planets found this way as of January 2006

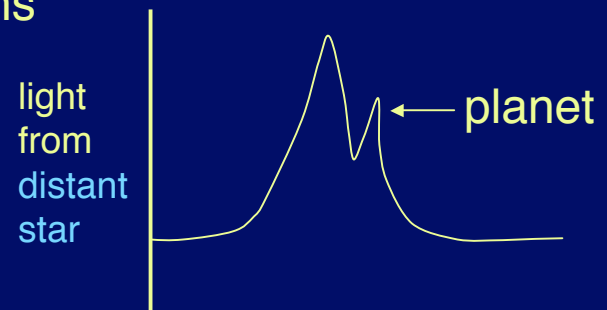

Planets from the Transit Method

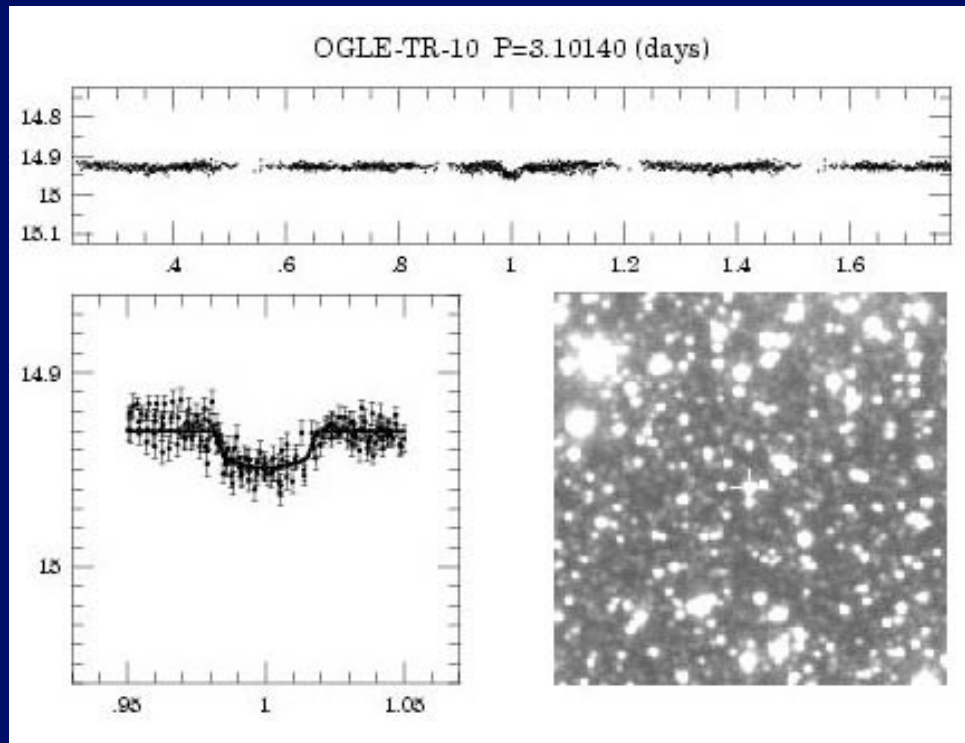

OGLE-TR-10

Light curve

Star field, shows star

Planet Detected by Microlensing

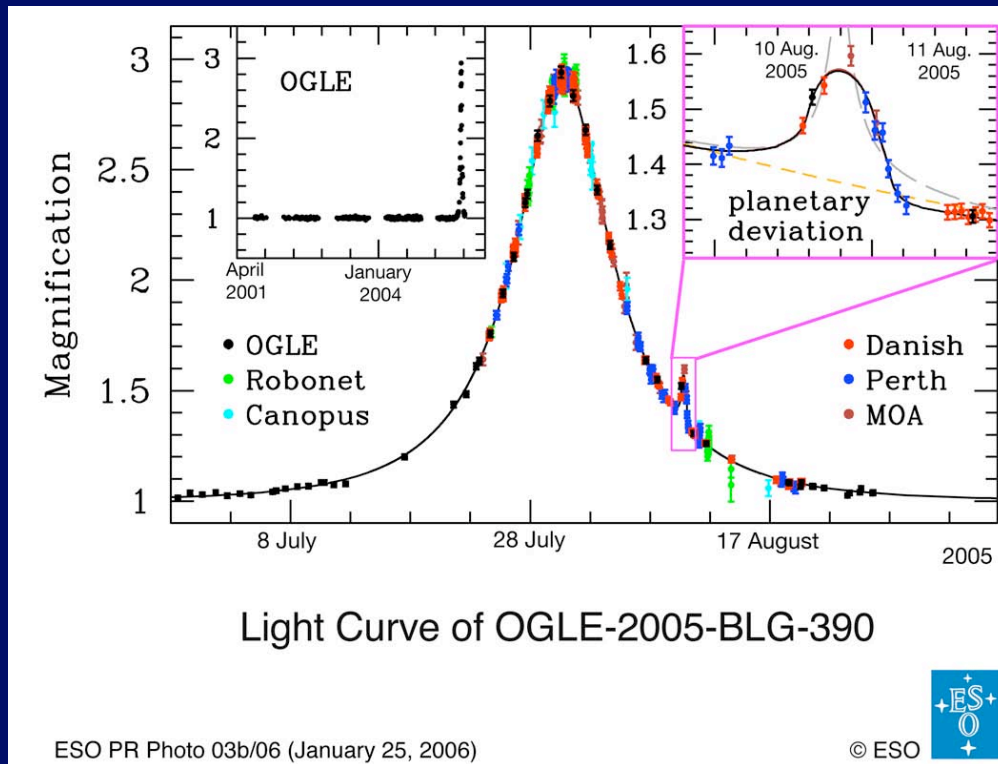

Sharp spike indicates second lens. Mass of second lens only 8×10^{-5} as massive as star. Most likely mass of planet is $5.5 M_{\text{earth}}$ and separation from star is 2.6 AU. Most likely star is low mass ($0.22 M_{\text{sun}}$).

This method can detect very low mass planets, but they are one-time events. Cannot follow up.

OGLE 2005-BLG-235Lb, announced 1/25/06

<http://www.eso.org/outreach/press-rel/pr-2006/pr-03-06.html>

Current Statistics (Jan. 2007)

- Based on Extrasolar Planets Encyclopedia
 - <http://exoplanet.eu/>
- 209 Planets in 171 systems
- 21 with multiple planets
- Most planets in one system is 4 (55 Cancri)
- Least massive
 - $M = 0.023 M_{\text{Jup}} = 7 M_{\text{earth}}$ (Gliese 876)
 - Claim of $5.5 M_{\text{earth}}$ (Microlens 1/25/06)

Implications of New Planets

Planets more massive than Jupiter can form around stars like the Sun.

Large Planets can form much closer to a star than Jupiter (or move there)

Does this mean we are unusual and our ideas about other planetary systems are just “solar system chauvinism”?

Not necessarily.

The ones found so far are the “easy” ones. (Big planets close to a star)

Now there are many more with lower masses than higher masses.

Too early to say that we are unusual.

Number of planets for different masses

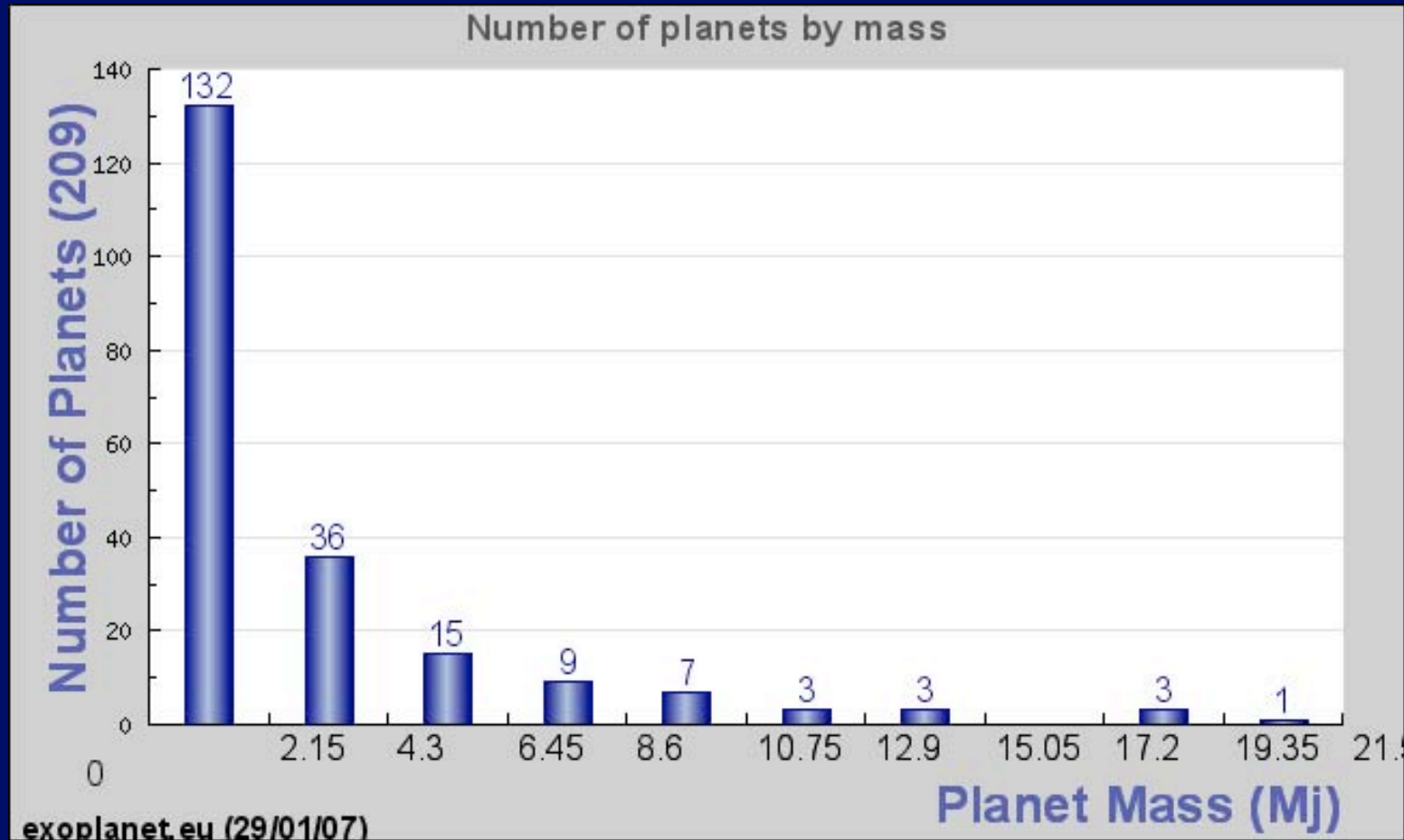

Estimating f_p

- Maximum? $f_p \sim 1$
 - All young stars may have disks
- Binaries?
 - Can have disks, but planet formation?
 - Even if form planets, orbits may not be stable
 - If reject binaries, $f_p < 0.3$

Estimating f_p

- Minimum?
 - Based on success rate of searches ($n_{\text{found}}/n_{\text{searched}}$)
 - Estimates now up to 5% ($f_p > 0.05$)
 - Note larger than 0.02 given in book
 - Extrapolate trends to finding
 - Smaller planets, larger orbits, ...
 - Estimates range from 0.11 to 0.25
- Allowed range: $f_p = 0.05$ to 1.0
 - Explain your choice!
 - Include/exclude binaries?

Comparative Image of Extrasolar Systems

PLANETS AROUND NORMAL STARS

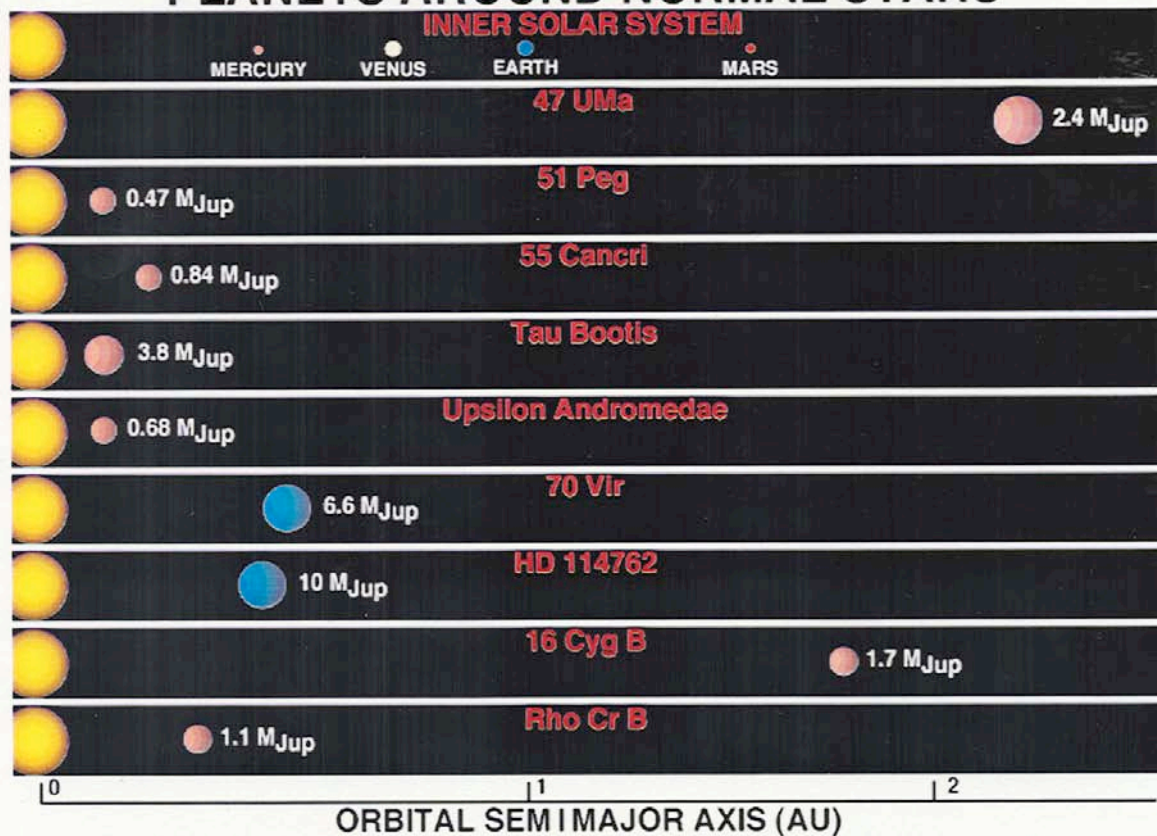

Courtesy San Francisco State University Astronomy Department

The Upsilon Andromedae System

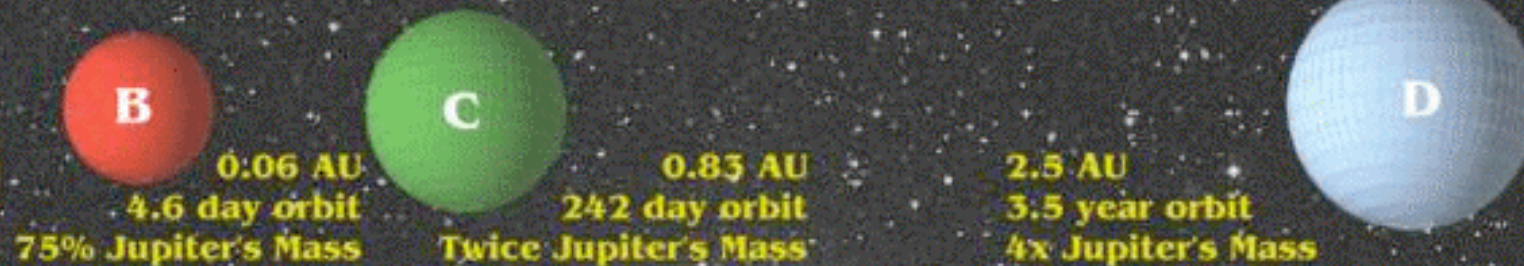

Our Inner Solar System

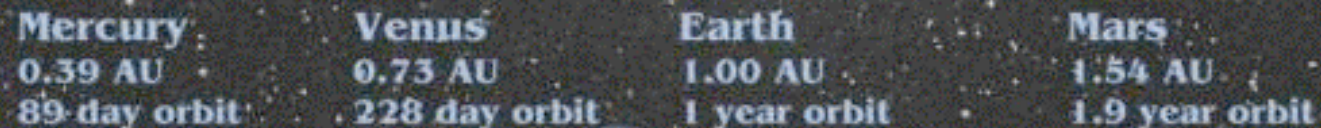

© Harvard-Smithsonian CFA (A. Condos), 1999

Artist's conception of the view from the outmost planet of three in Upsilon Andromedae



Copyright Lynette Cook
used with permission

<http://www.extrasolar.spaceart.org>

Artist's conception of Transit of HD209458

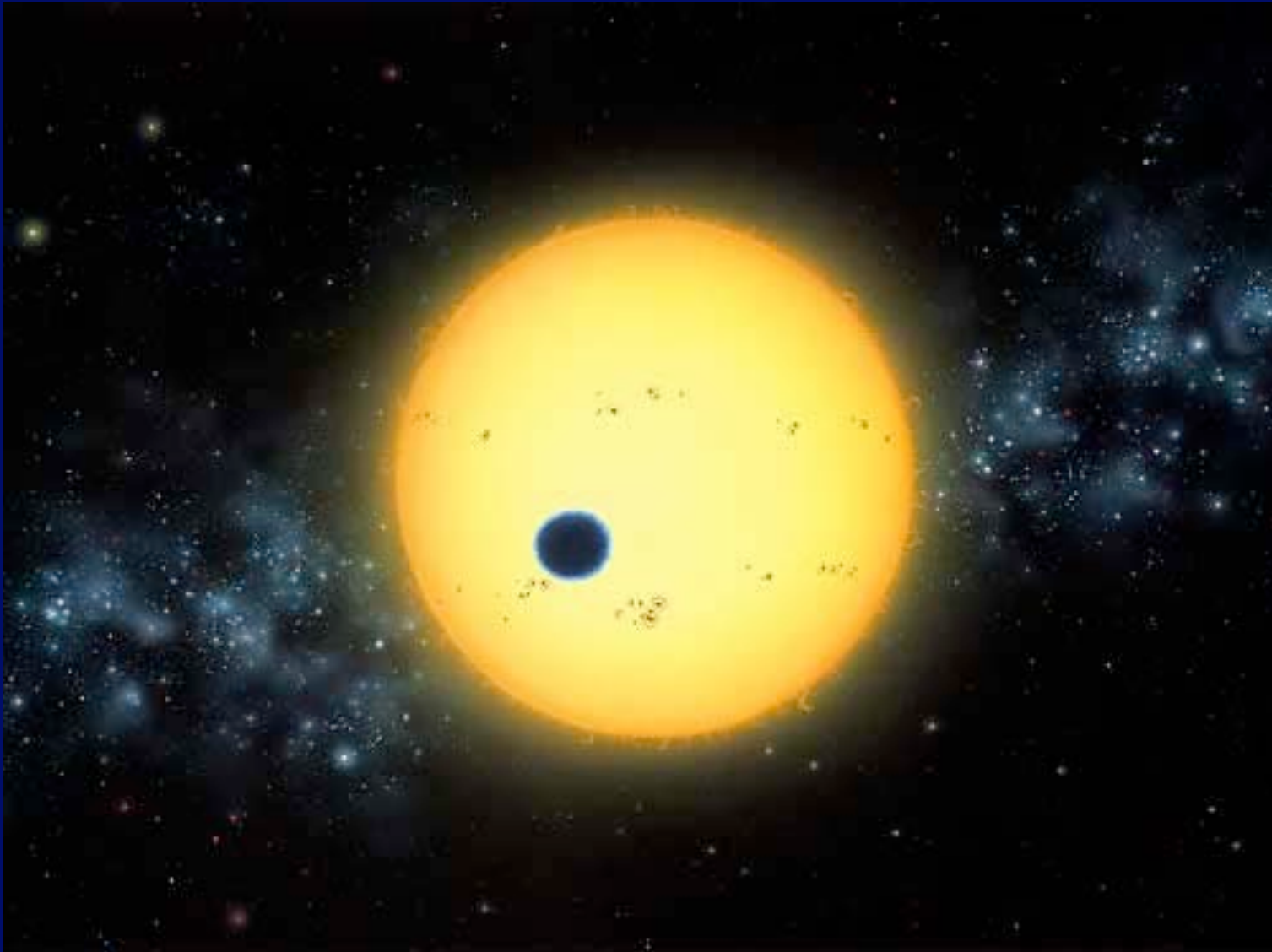

Copyright Lynette Cook
used with permission

<http://www.extrasolar.spaceart.org>

Artist's conception of 47 U ma "view" from Moon of the Second Planet



Copyright Lynette Cook
used with permission

<http://www.extrasolar.spaceart.org>

Future Prospects

Direct detection (and study) of Earth-like planets

~ 2015 Terrestrial Planet Finder (TPF)

Darwin (Europe)

Astrometric Method

GAIA ~ 2012

M_J Planets out to 600 ly.

Further Spectroscopic Searches

Transits

Kepler (~ 2008)

Monitor 100,000 stars for 4 years

“Hundreds of Terrestrial Planets”

Direct Detection in Future

- Terrestrial Planet Finder (TPF)/Darwin
 - TPF-C Visible light coronagraph (~2014)
 - TPF-I Infrared interferometer (~2020)
- Goal is to detect earth-mass planets
- And to see what gases in atmosphere
 - Suitable for life?
- http://planetquest.jpl.nasa.gov/TPF/tpf_index.html

TPF Concepts

TPF-I Infrared Interferometer (2020)



TPF-C Visible light coronagraph (2014)

Spectroscopy of atmosphere

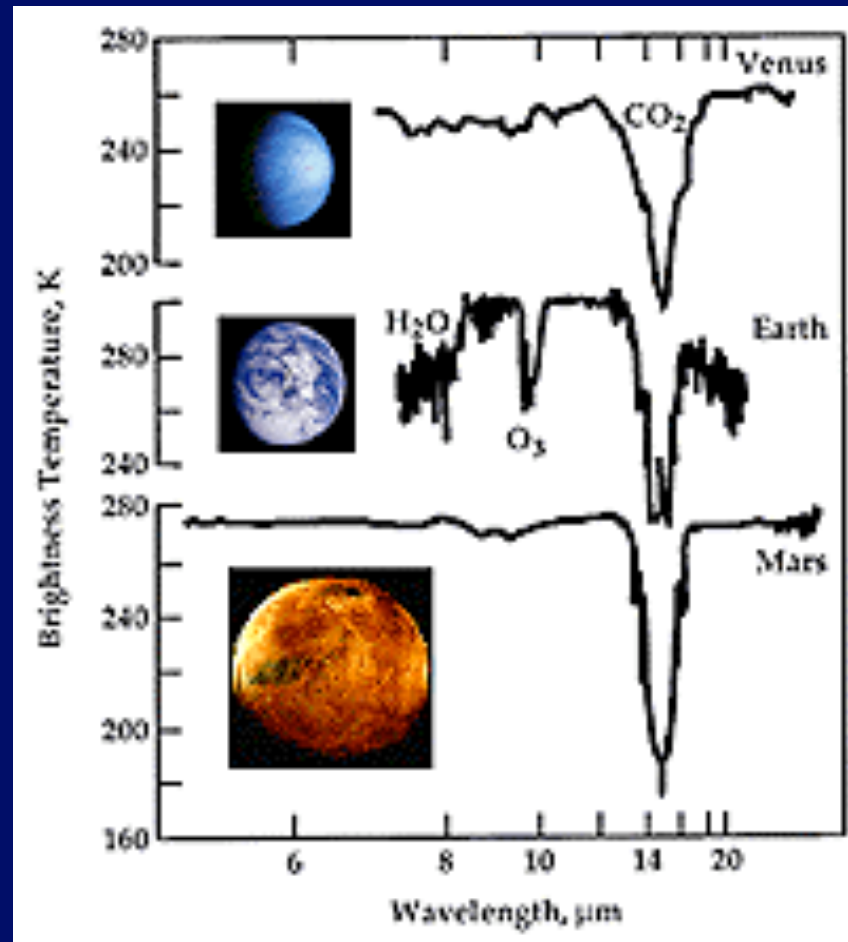

Planet Detection Methods

Michael Perryman, Rep. Prog. Phys., 2000, 63, 1209 (updated November 2004)

[corrections or suggestions please to michael.perryman@esa.int]

