

Life

What is necessary for life?

Most life familiar to us: Eukaryotes

FREE LIVING
Or Parasites

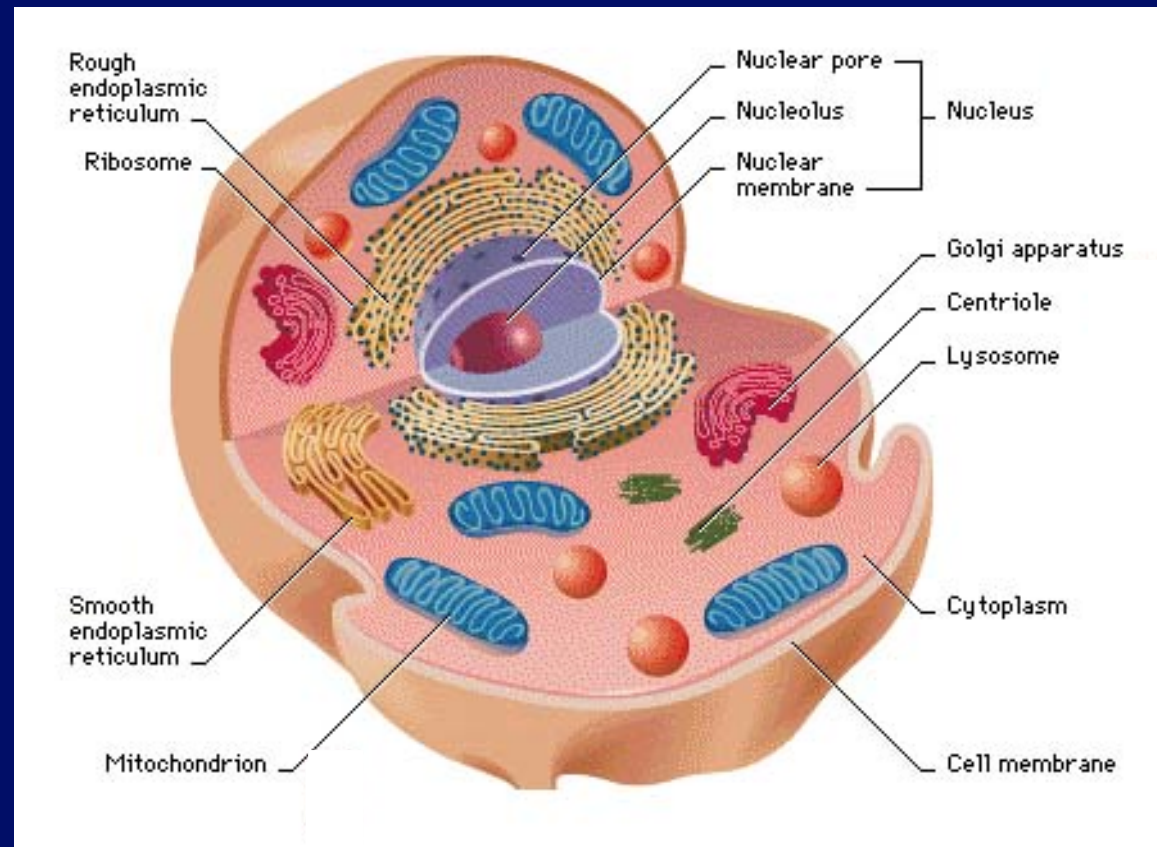

First appeared $\sim 1.5 - 2 \times 10^9$ years ago

Requirements: DNA, proteins, lipids, carbohydrates,
complex structure, $\sim 10^4 - 10^5$ genes

Prokaryotes (Bacteria and Archaea)

First appeared

$\sim 3 - 4 \times 10^9$ years ago

FREE LIVING
Or Parasites

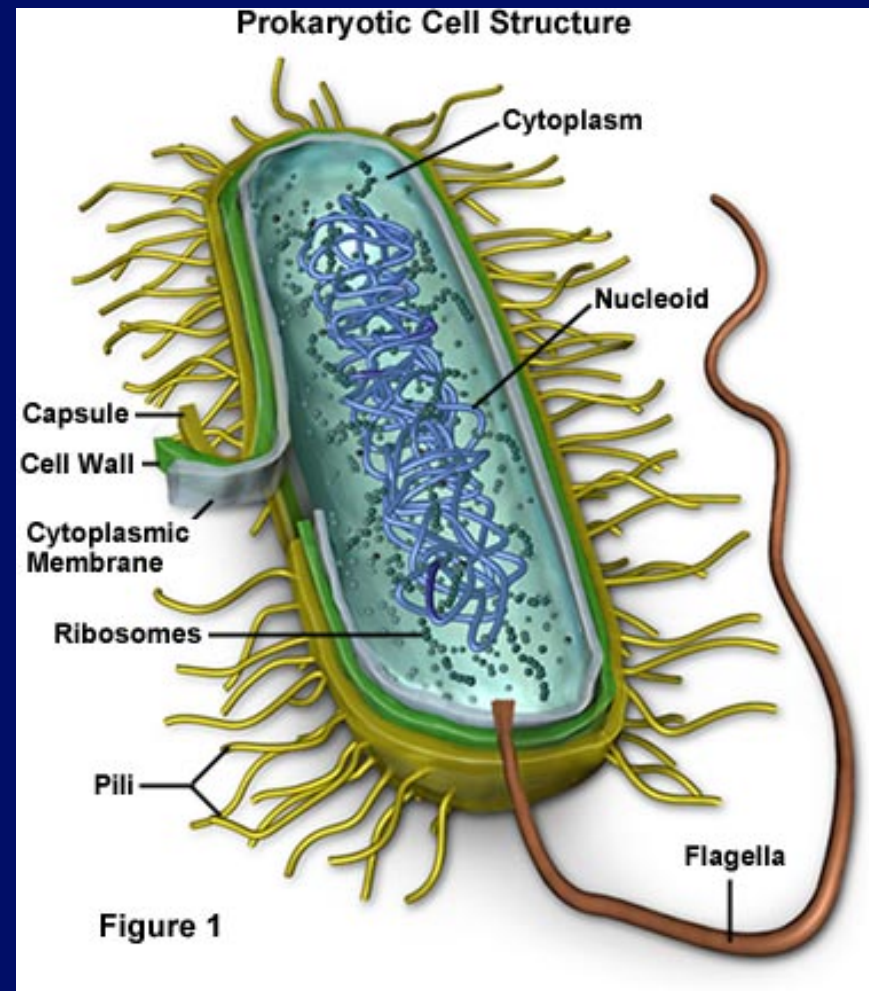

Requirements: DNA, protein, lipids, carbohydrates,
simpler structure, few thousand genes

Viruses

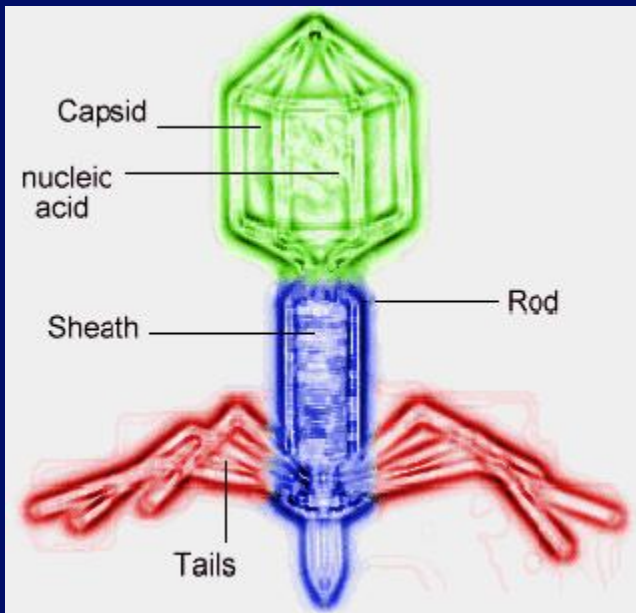

DNA, protein

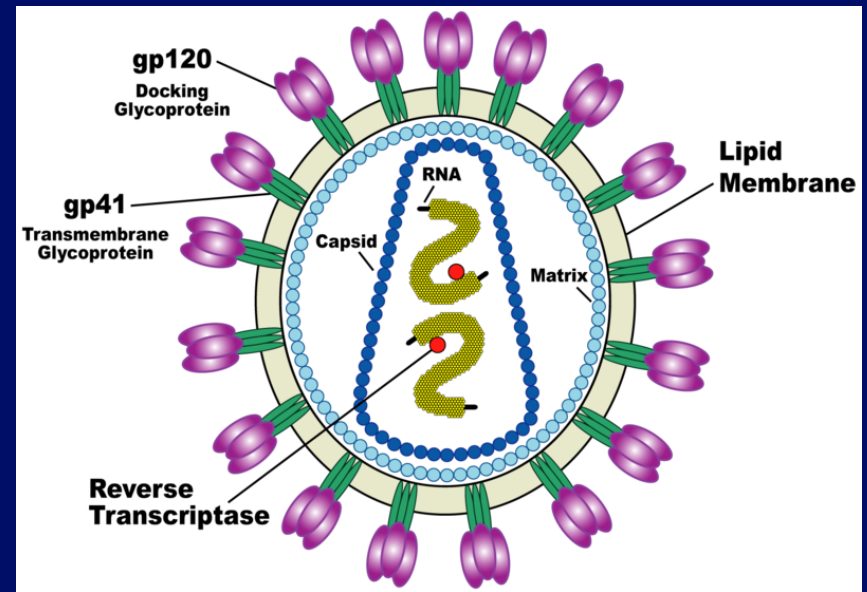

RNA, protein, maybe lipid
(e.g., HIV)

All are parasites. Are they alive?

The tobacco-mosaic virus is made up of a strand of nucleic acid encased in a rod of one kind of protein.

TOBACCO MOSAIC VIRUS

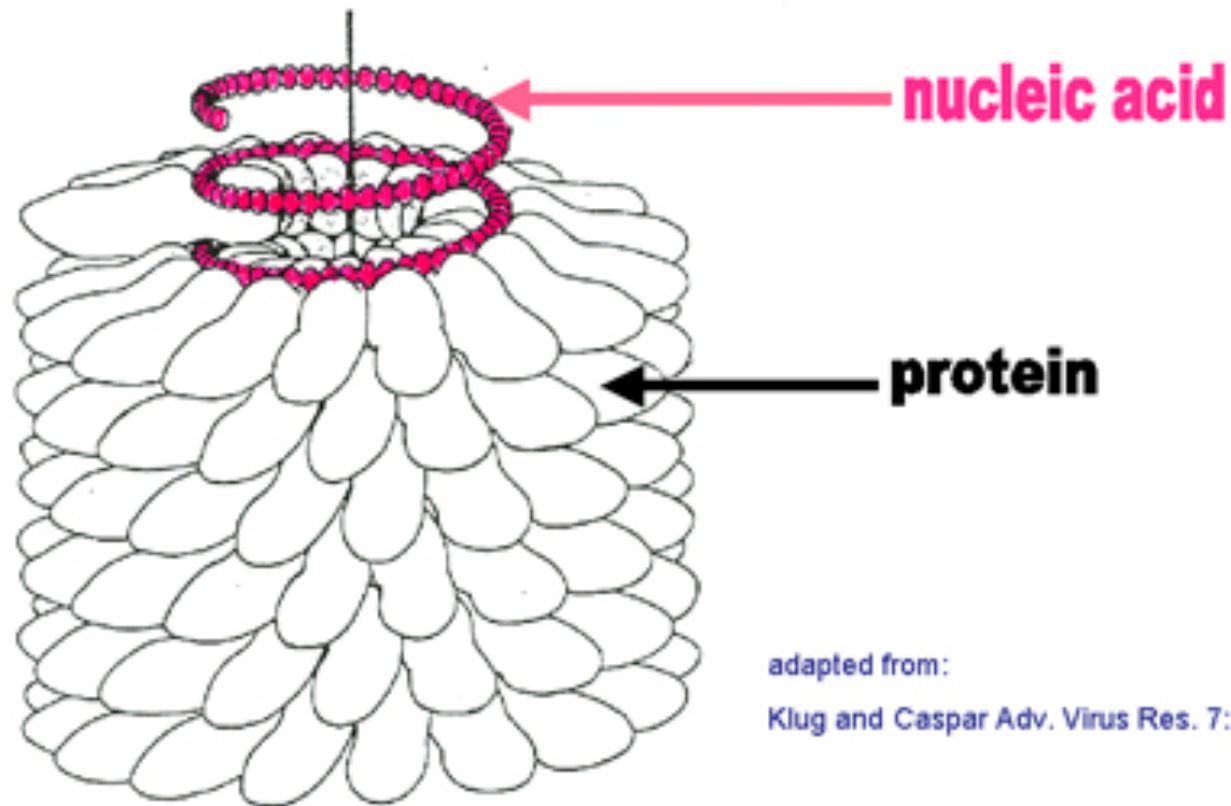

Even Simpler

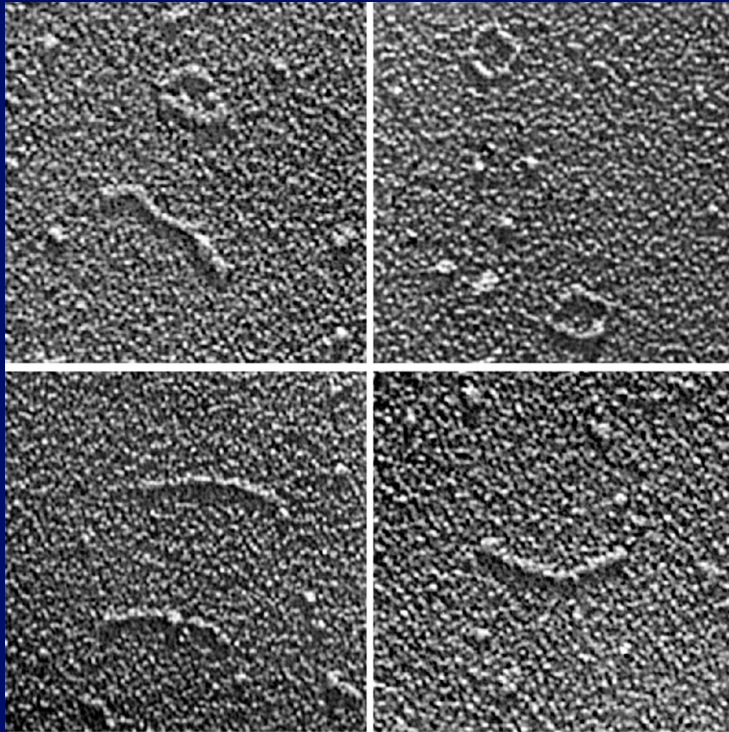

Viroids
Bare, single-stranded
RNA

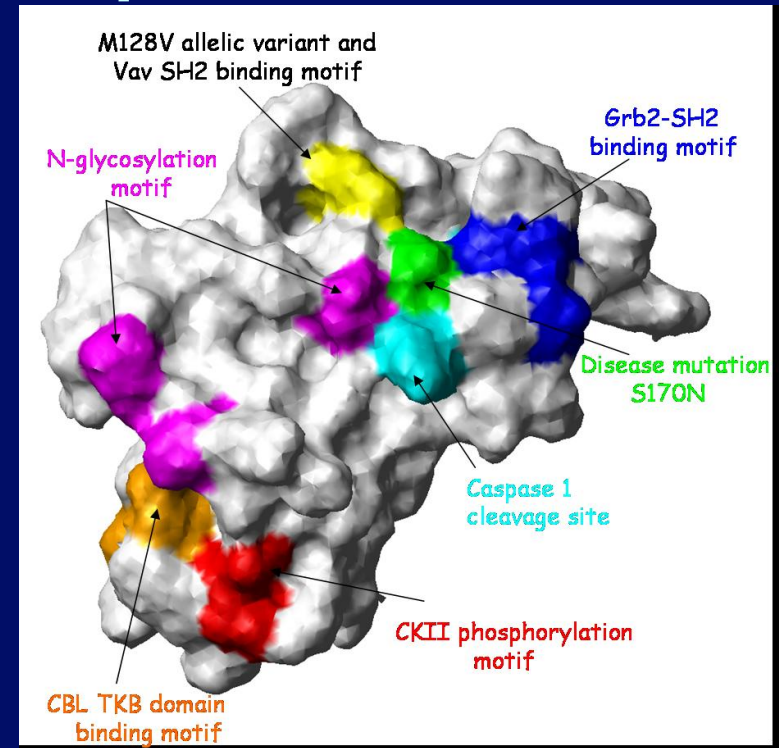

Prions
Misfolded proteins
Can induce others to
Misfold.

Minimum Requirements for Life

Proteins and Nucleic Acids for simplest possible life.

Or maybe only one?

Lipids and Carbohydrates for any thing more complex than a virus.

These are all macromolecules.

Macromolecules

H, C, N, O
(S)

Proteins made of amino acids
(20 kinds used in proteins)

Construction and catalysis (enzymes)

H, C, N, O
(P)

Nucleic acids made of nucleotides

base sugar phosphate

Polymers made of Monomers

H, C, O

Carbohydrates made of sugars

Energy (food) + structure

[starch]

[cellulose]

H, C, (O)

Lipids (hydrocarbons + carboxyl)

Membranes + Energy

[water-resistant]

Sugar

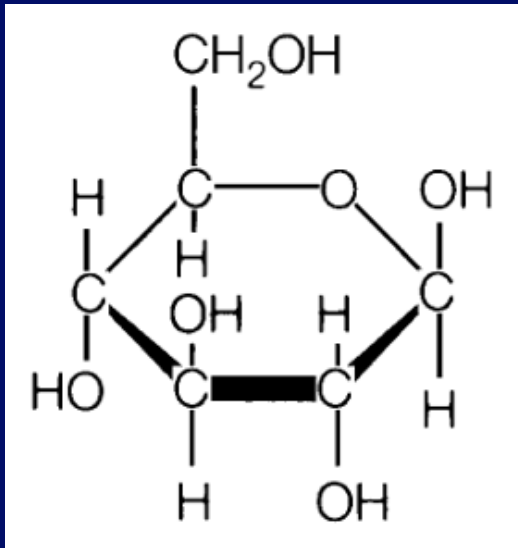

Glucose

Lipids

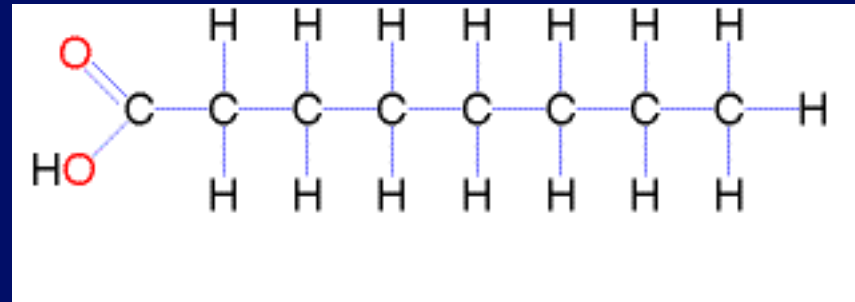

carboxyl

hydrocarbon

Fatty acid is composed of a hydrocarbon chain with a carboxyl group at one end

Polysaccharides

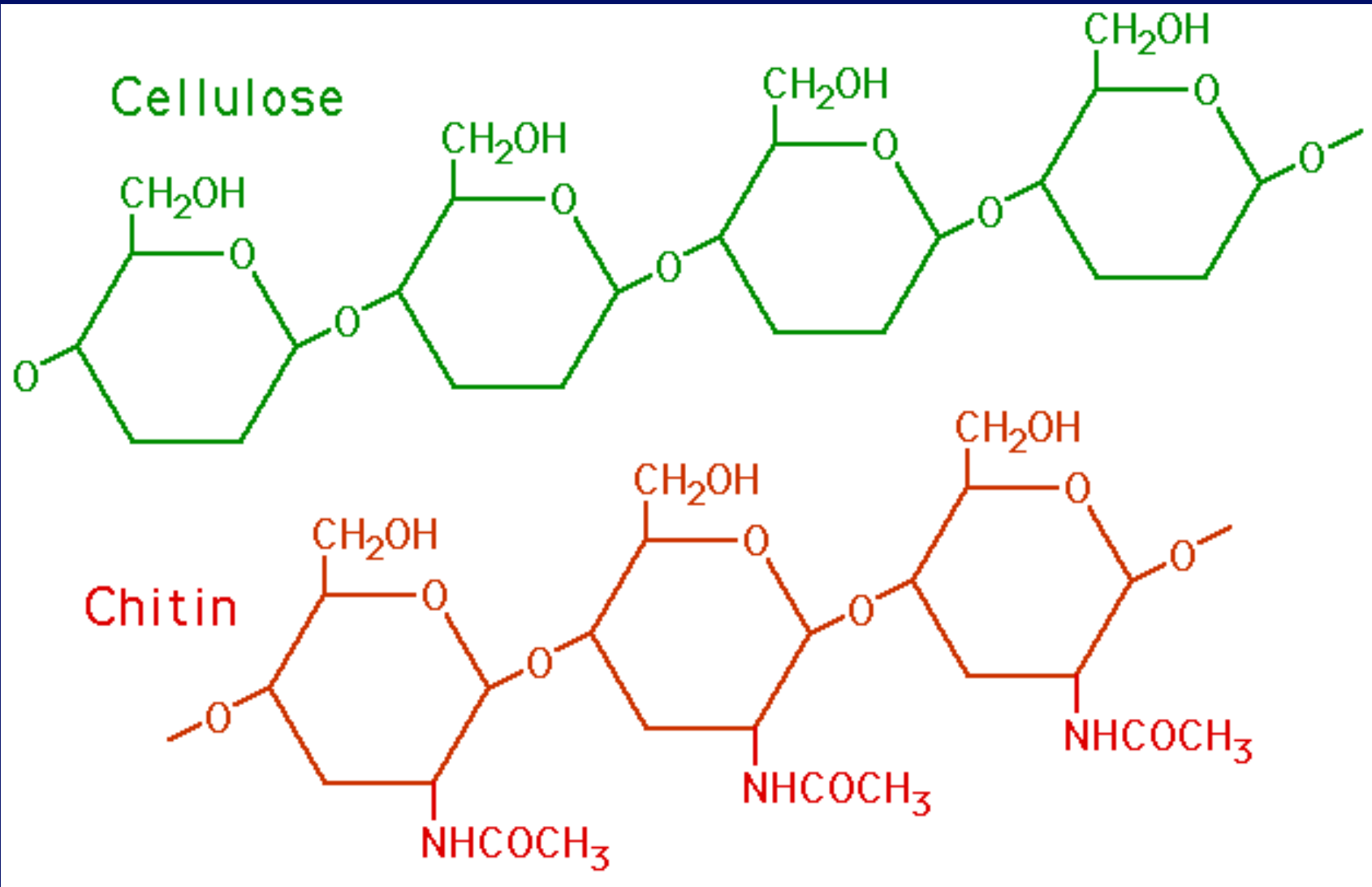

Proteins

Monomers are amino acids

20 kinds

Glycine

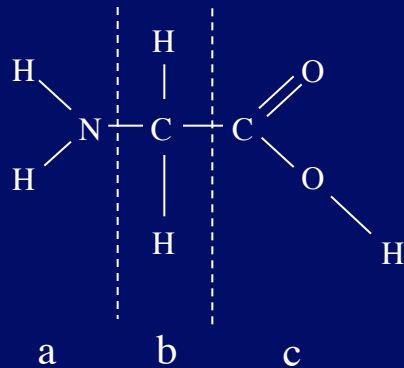

Amino group

carboxyl group

Schematic

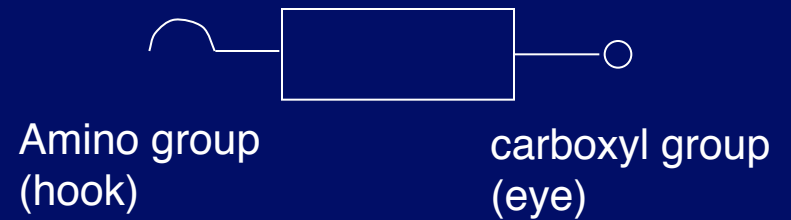

Section of Protein

A Peptide Bond at the Chemical Level

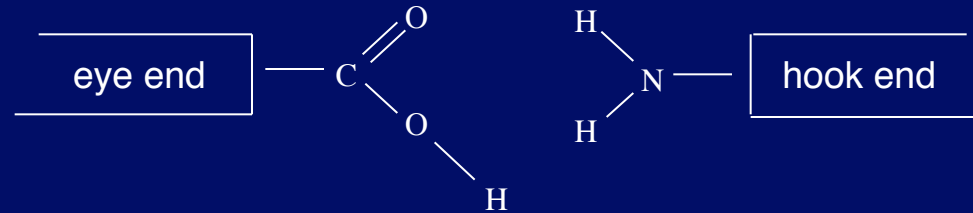

Before

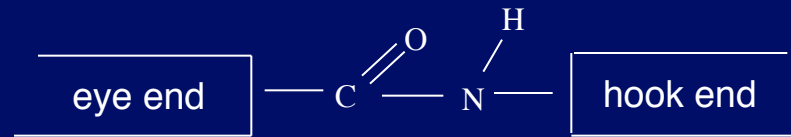

After

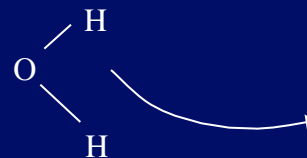

Note that a water molecule must be removed

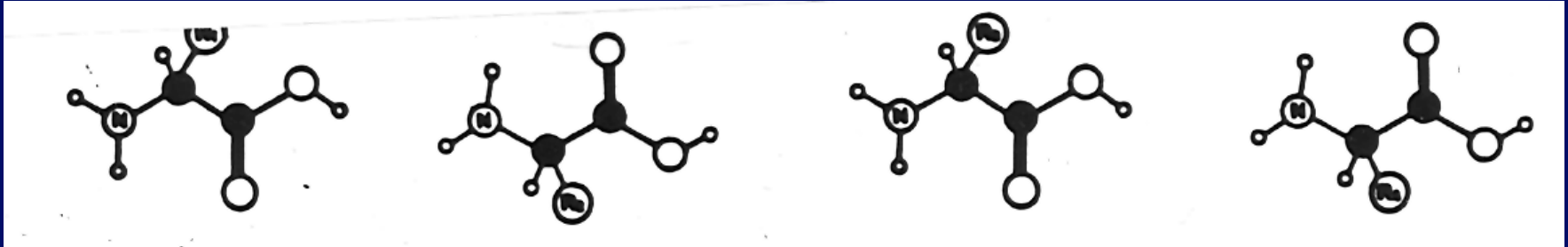

amino acids

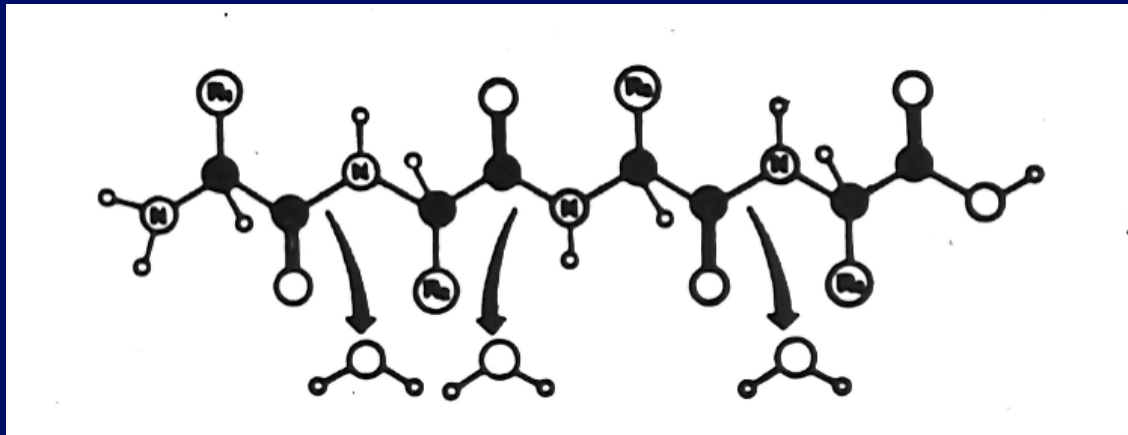

protein

Stripped down view
Can you find the
amino end and the
carboxyl end?

Note the “heme”,
containing iron.

Function depends on
structure, which
depends on folding,
which depends on
order of amino acid
bases

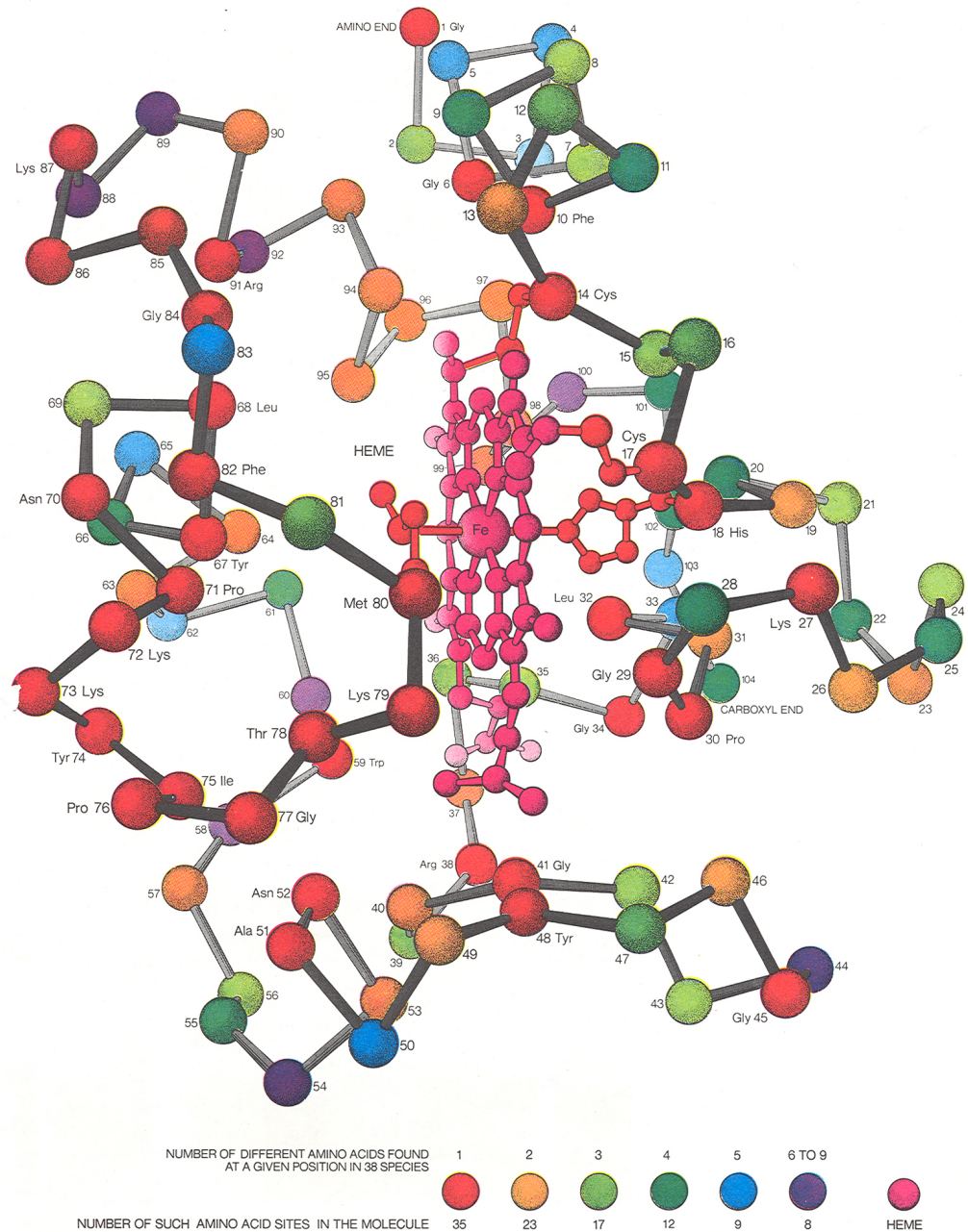

Nucleic Acids (DNA, RNA)

Made of sugars, phosphates, bases

Sugar

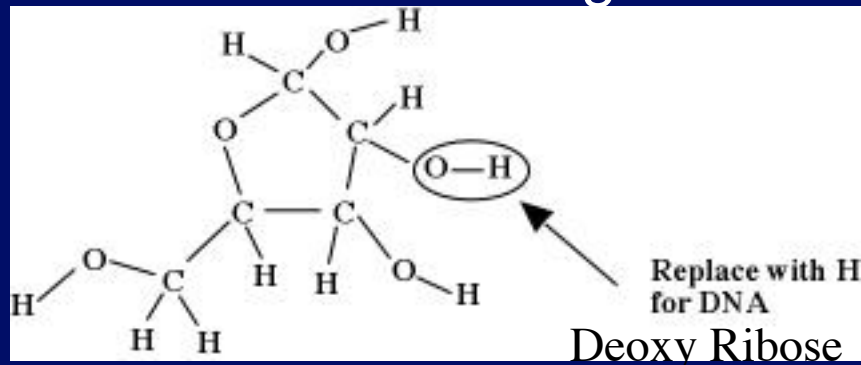

Schematic

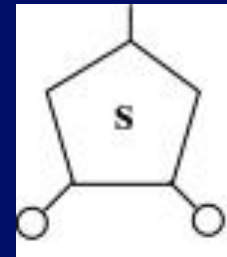

Ribose Sugar
5 C, 5 O, 10 H

Ribonucleic acid (RNA) uses ribose sugar;
Deoxyribonucleic acid (DNA) uses deoxyribose sugar

phosphate

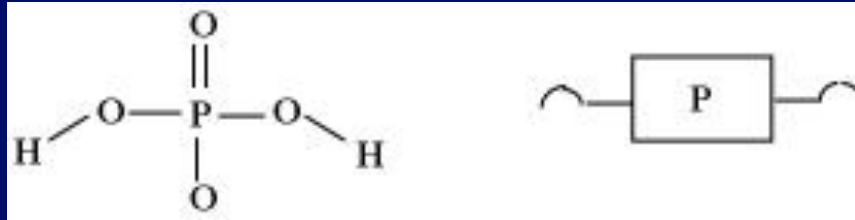

sugars & phosphates linked
phosphodiester bonds

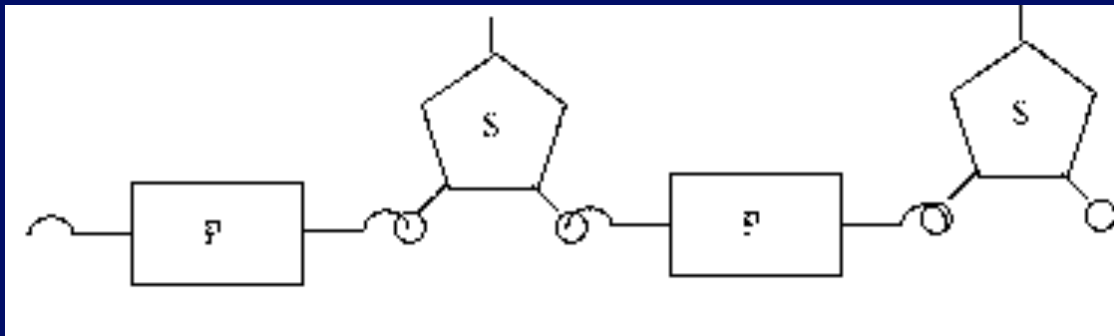

Segment of side of ladder structure

Nucleic Acids (cont.)

Bases: Carry Genetic Code

Purines

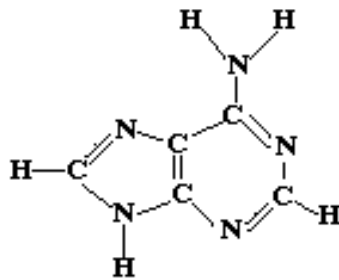

Adenine

Adenine

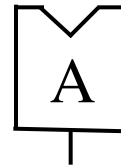

Guanine

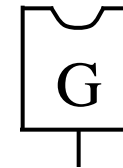

Equal numbers of C and N

Pyrimidines

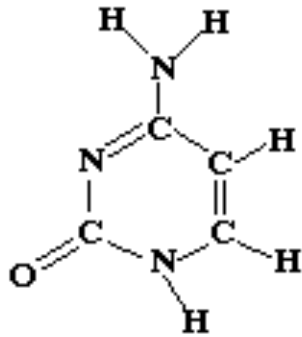

Cytosine

More C than N

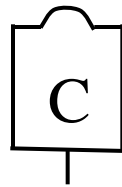

Cytosine

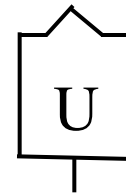

Uracil / Thymine

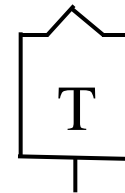

RNA / DNA

Bases in Nucleic acids: Purines and Pyrimidines

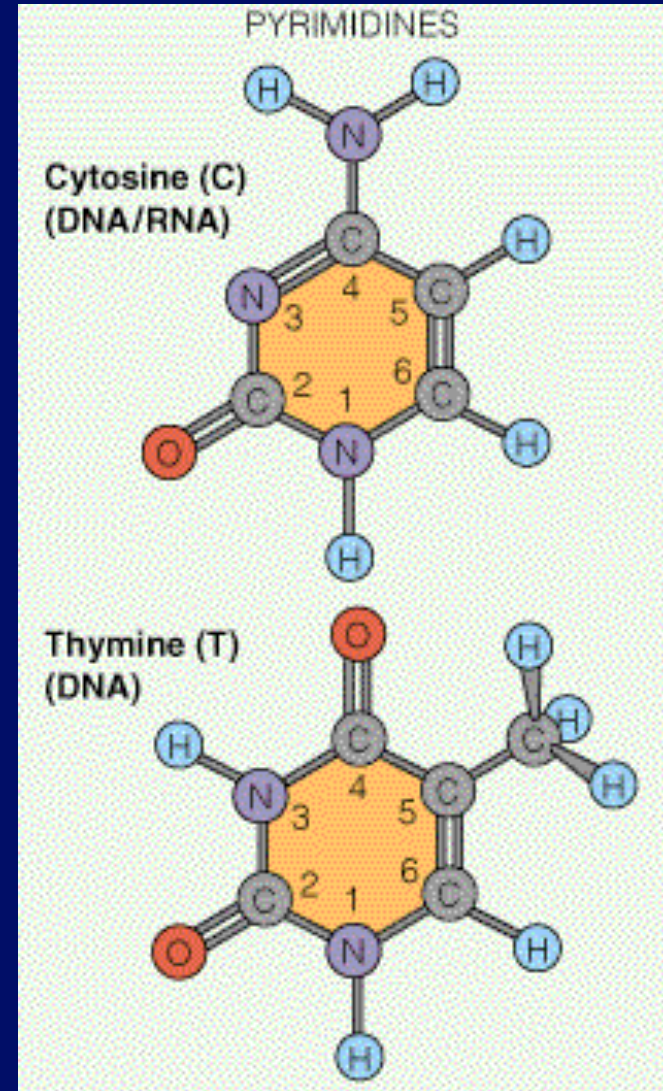
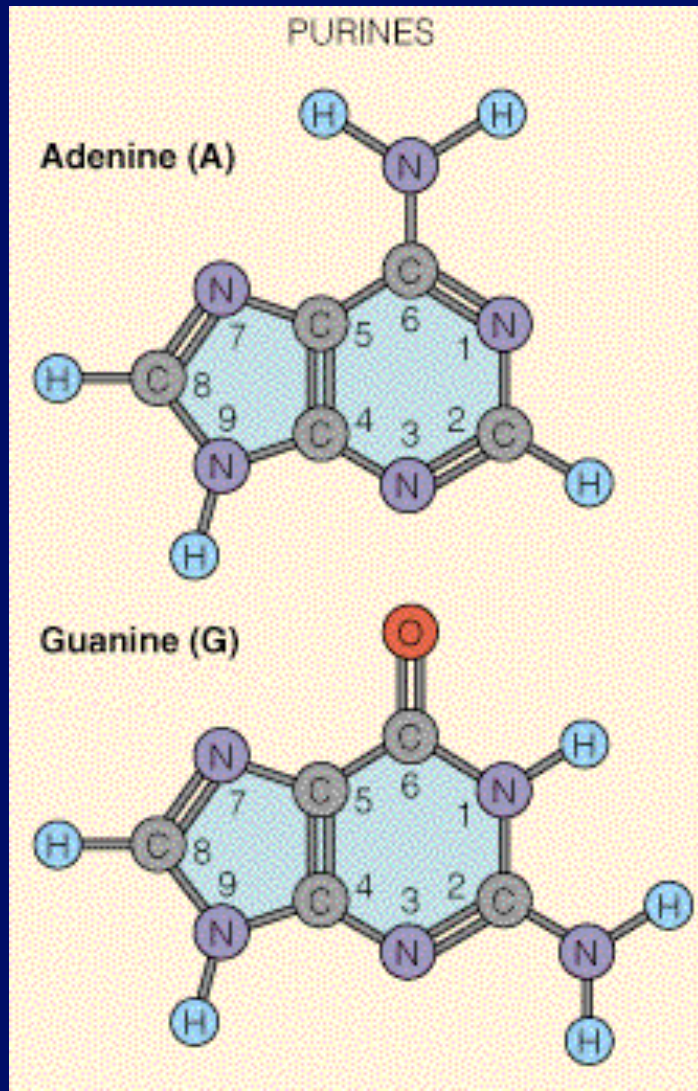

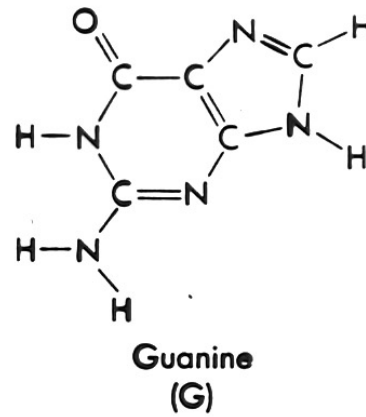
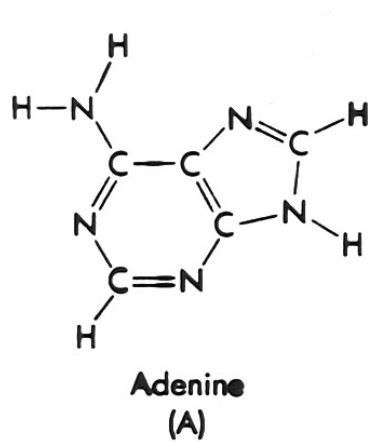

Pyrimidines

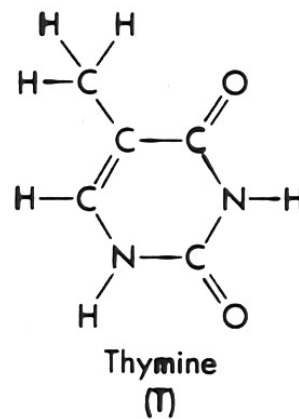
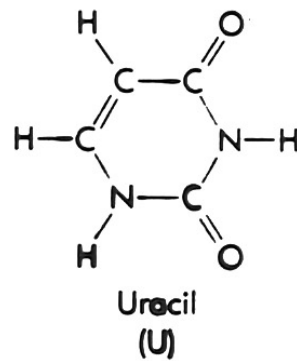
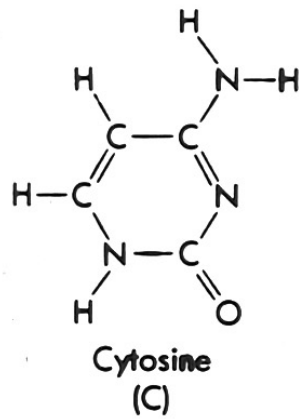

Purines

Pyrimidines

Note Uracil

Nucleic Acids (cont.)

Segment of RNA

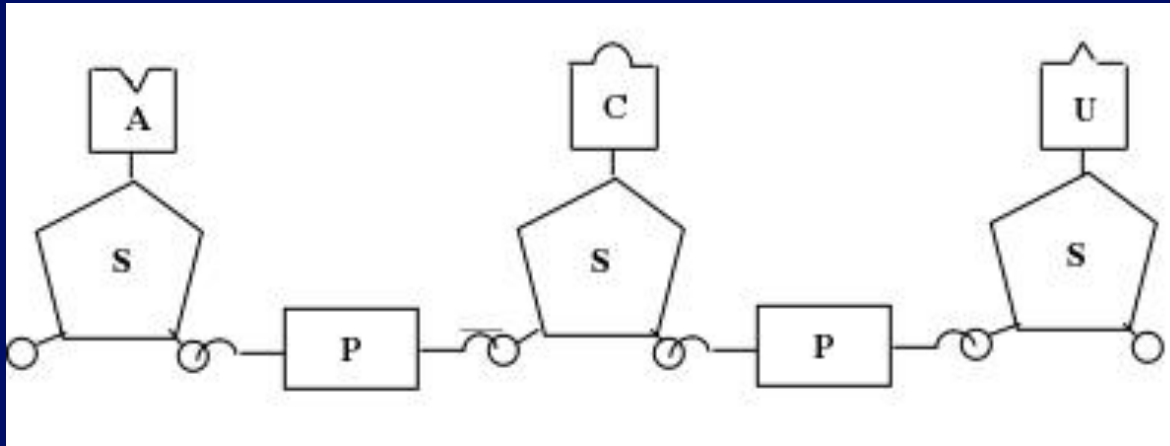

Segment of DNA

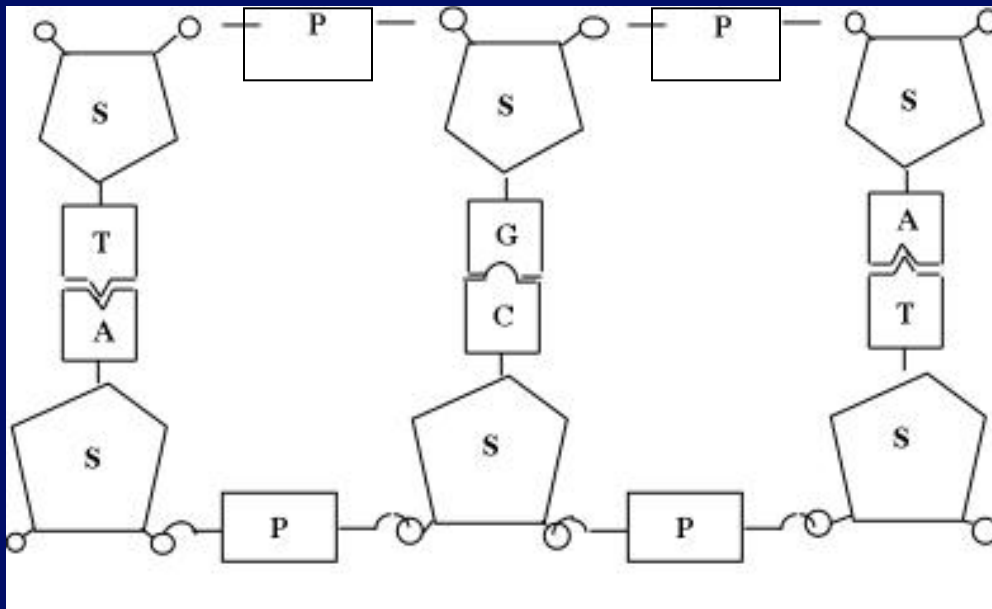

Note that T replaces U in DNA

At the Chemical Level

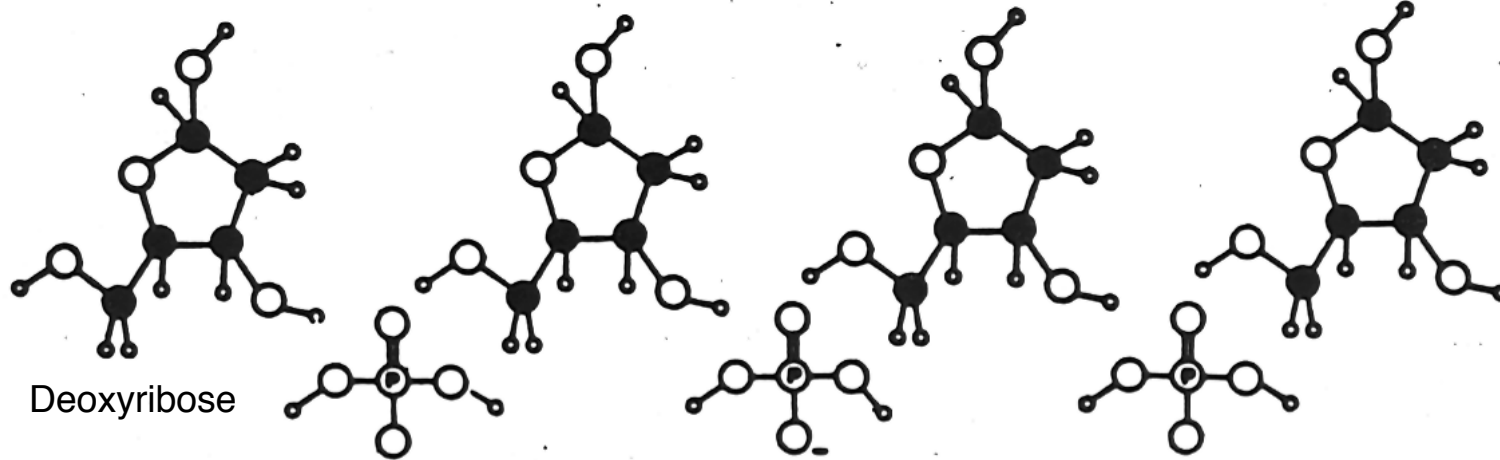

Deoxyribose

Phosphate

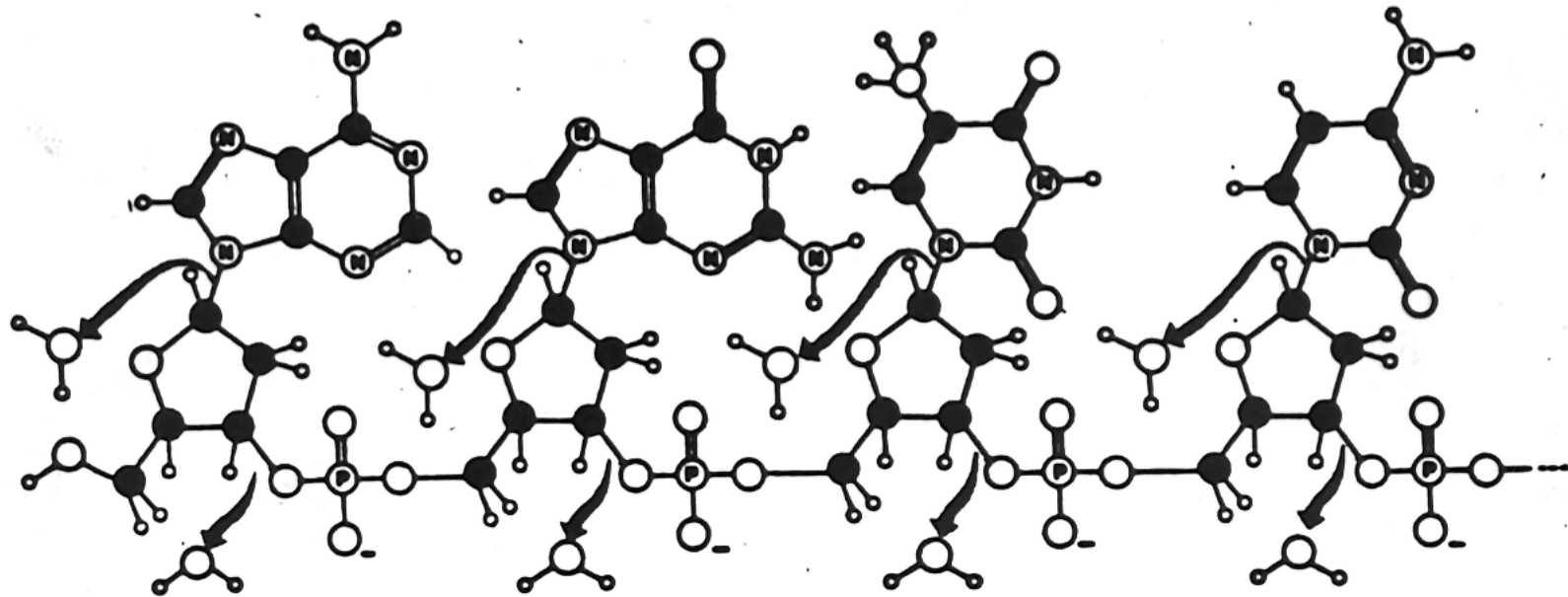

Deoxyribonucleic Acid (DNA)

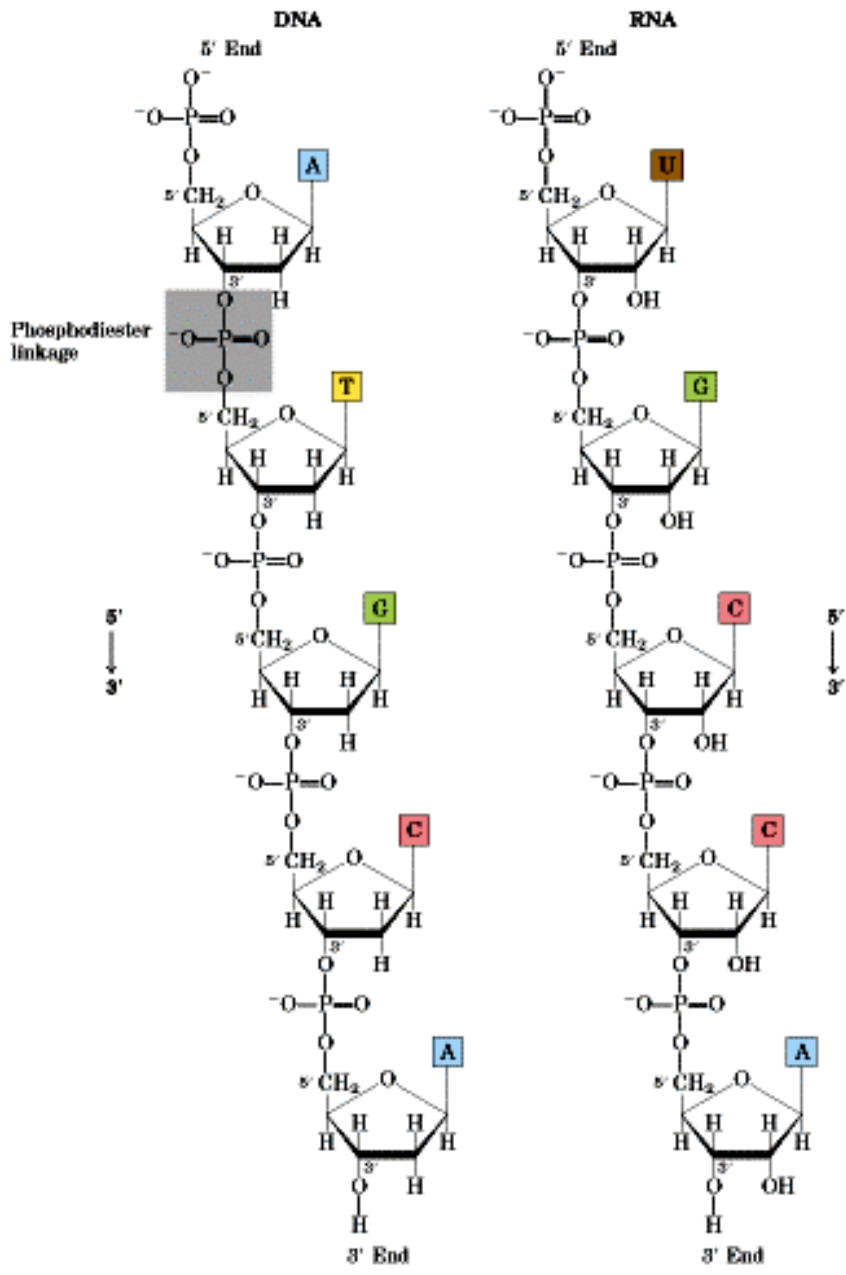

The two strands of DNA form a double helix, connected between bases by hydrogen bonds

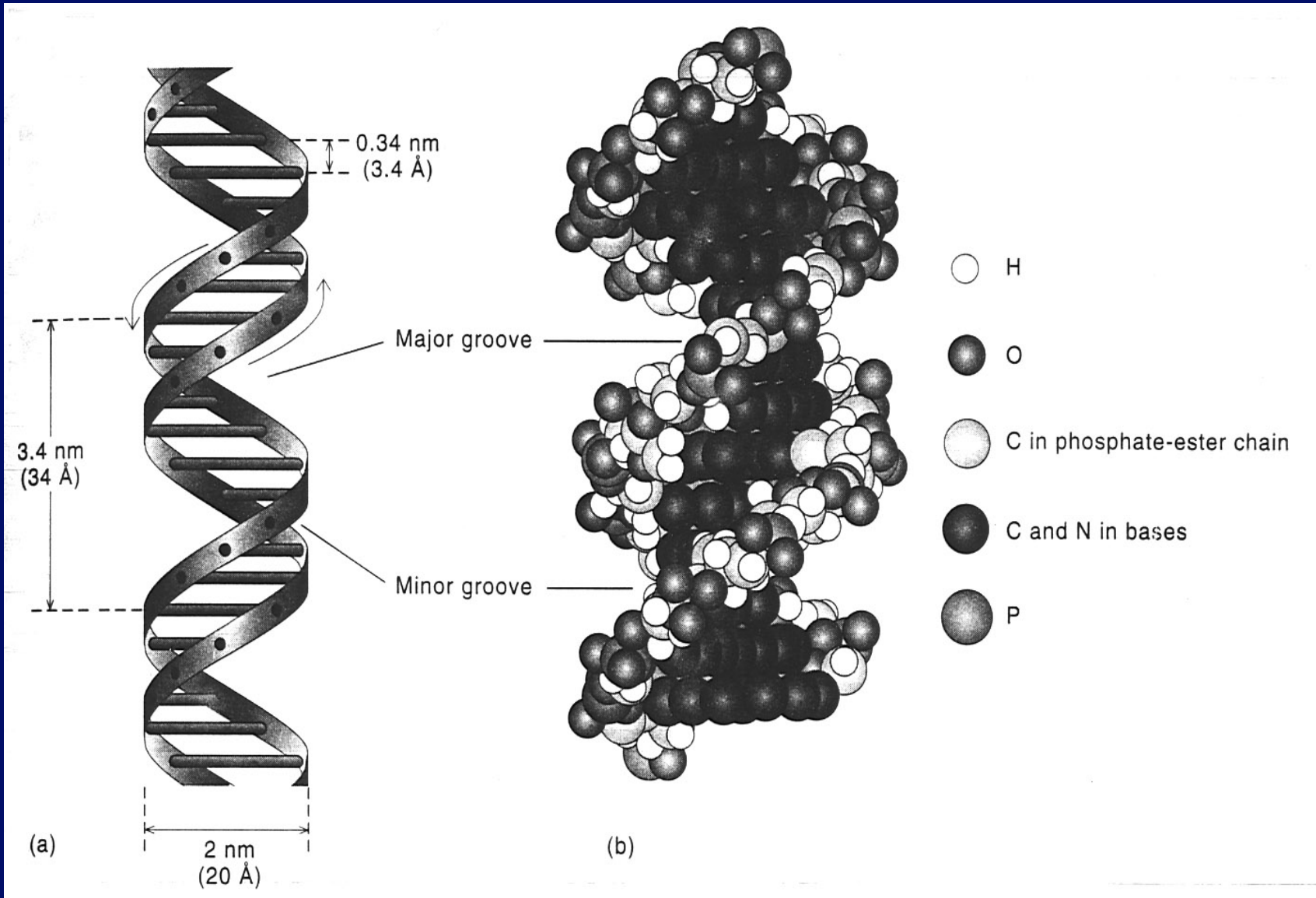

Hydrogen Bonds (weak) connect the bases across the two sides of DNA

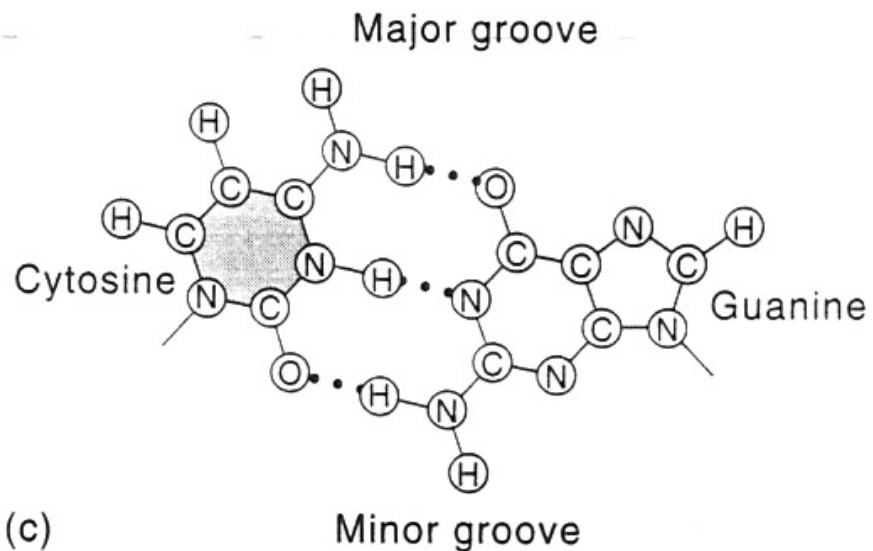
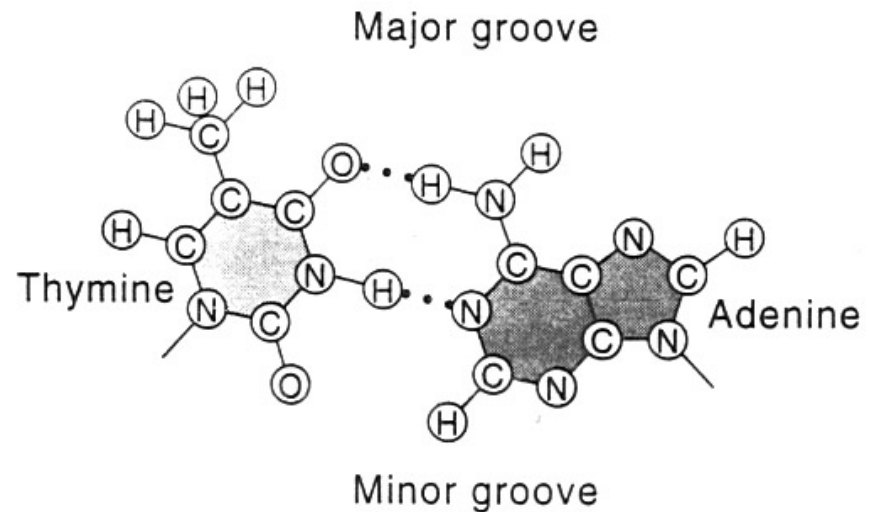

Segment of DNA

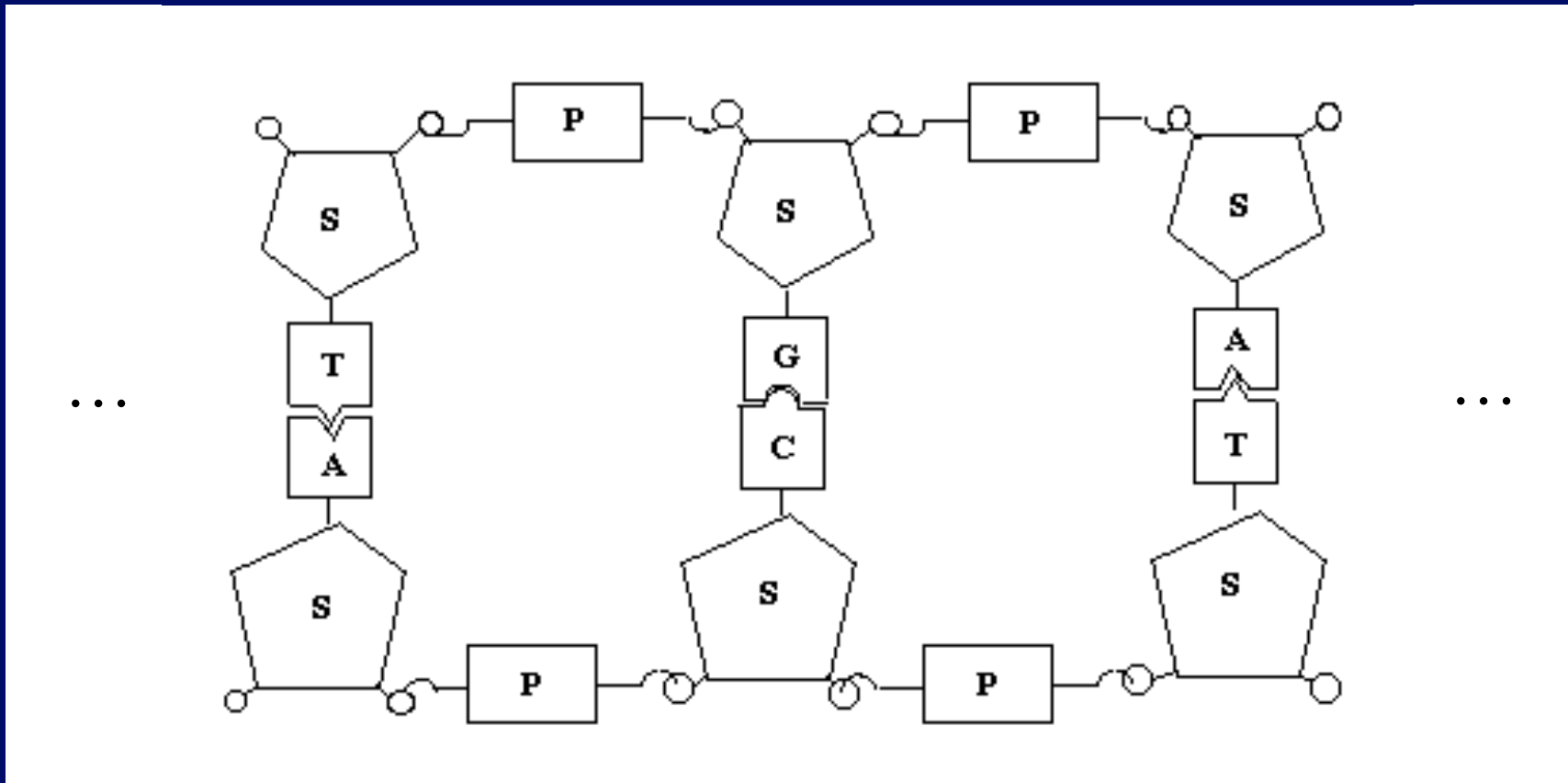

Further wrapping to make compact chromosome

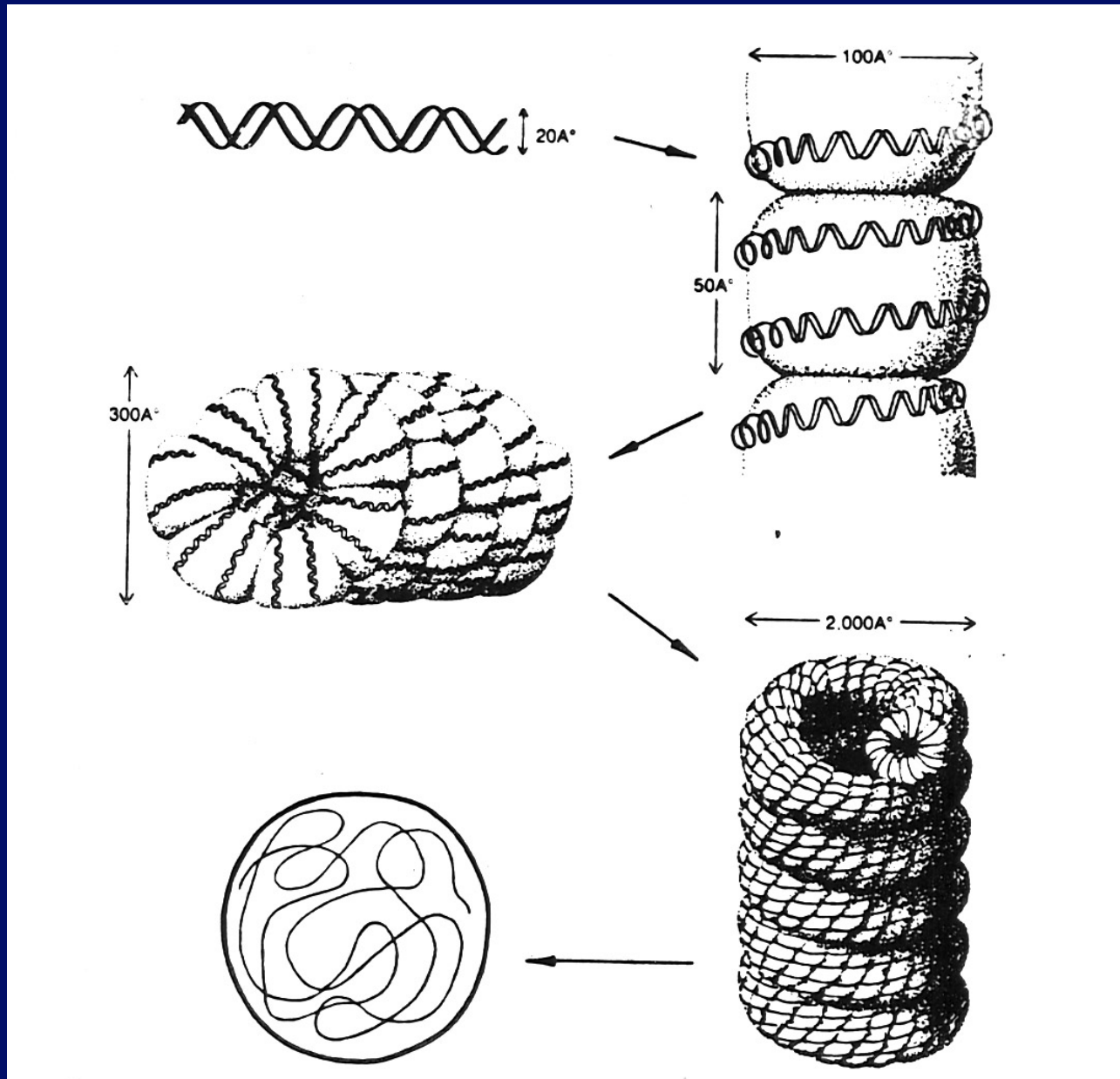

Information Storage

- Nucleic acids store information
- The information specifies proteins
- The information can be replicated
- This allows inheritance

Base pairing rules

A - T

G - C

- U

⇒ Replication of order
(reproduction)

Nucleic Acids and Proteins communicate
through the **Genetic Code**

Codon

3 base sequence specifies an Amino Acid

Gene

Sequence of codons specifies a Protein

a gene specifies a protein

e.g.	tobacco mosaic virus	4 genes
	bacteria	$\sim 10^3$ genes
	human cell	$\sim 23,000$ genes

For mRNA

Genetic Code

First RNA Base	Second RNA Base				Third RNA BASE
	U	C	A	G	
U	Phenylalanine	Serine	Tyrosine	Cysteine	U
	Phenylalanine	Serine	Tyrosine	Cysteine	C
	Leucine	Serine	Stop	Stop	A
	Leucine	Serine	Stop	Tryptophan	G
C	Leucine	Proline	Histidine	Arginine	U
	Leucine	Proline	Histidine	Arginine	C
	Leucine	Proline	Glutamine	Arginine	A
	Leucine	Proline	Glutamine	Arginine	G
A	Isoleucine	Threonine	Asparagine	Serine	U
	Isoleucine	Threonine	Asparagine	Serine	C
	Isoleucine	Threonine	Lysine	Arginine	A
	Start/Methionine	Threonine	Lysine	Arginine	G
G	Valine	Alanine	Aspartic Acid	Glycine	U
	Valine	Alanine	Aspartic Acid	Glycine	C
	Valine	Alanine	Glutamic Acid	Glycine	A
	Valine	Alanine	Glutamic Acid	Glycine	G

Amino Acids

PROTEIN SYNTHESIS

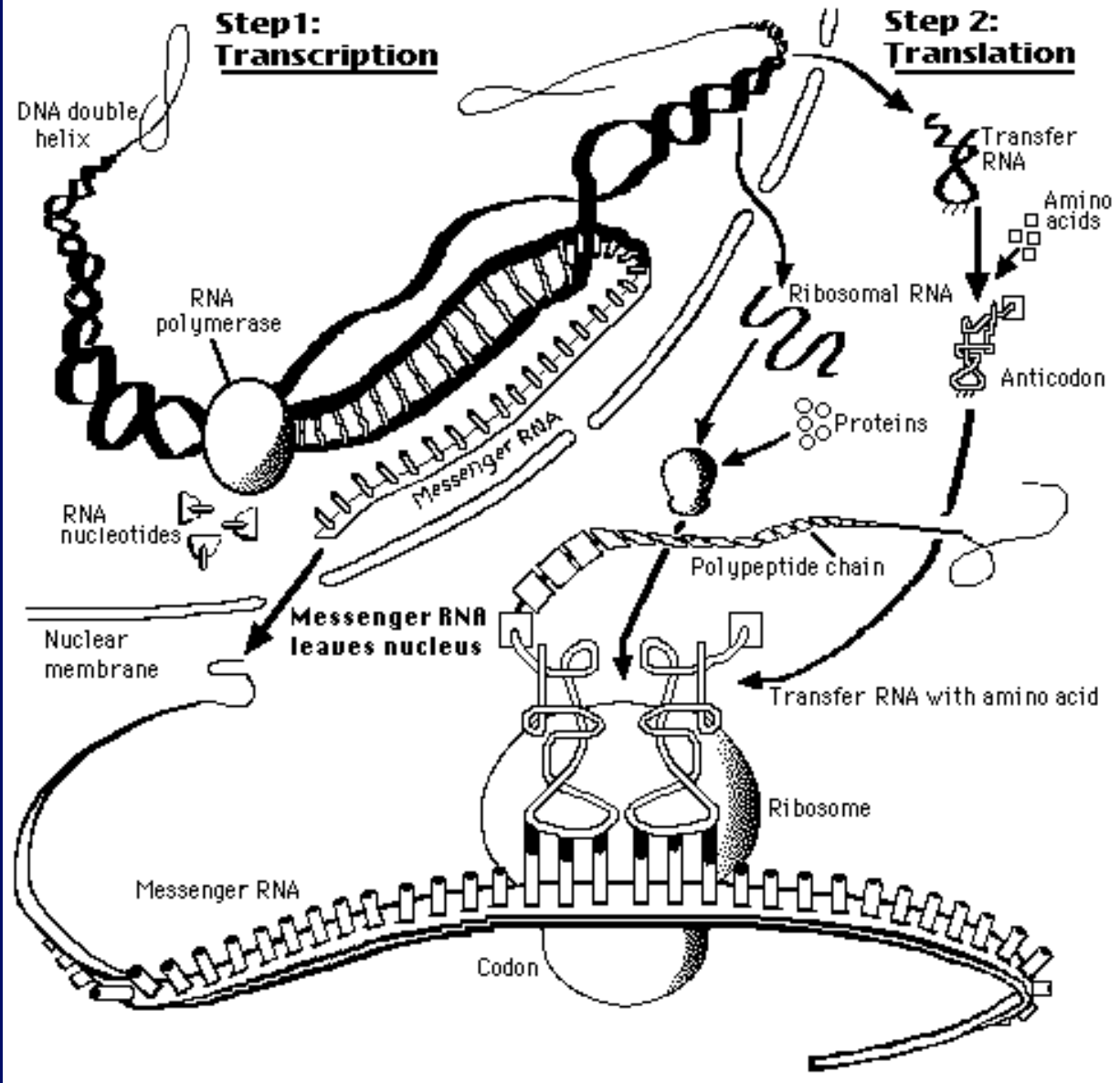

Structure of a tRNA

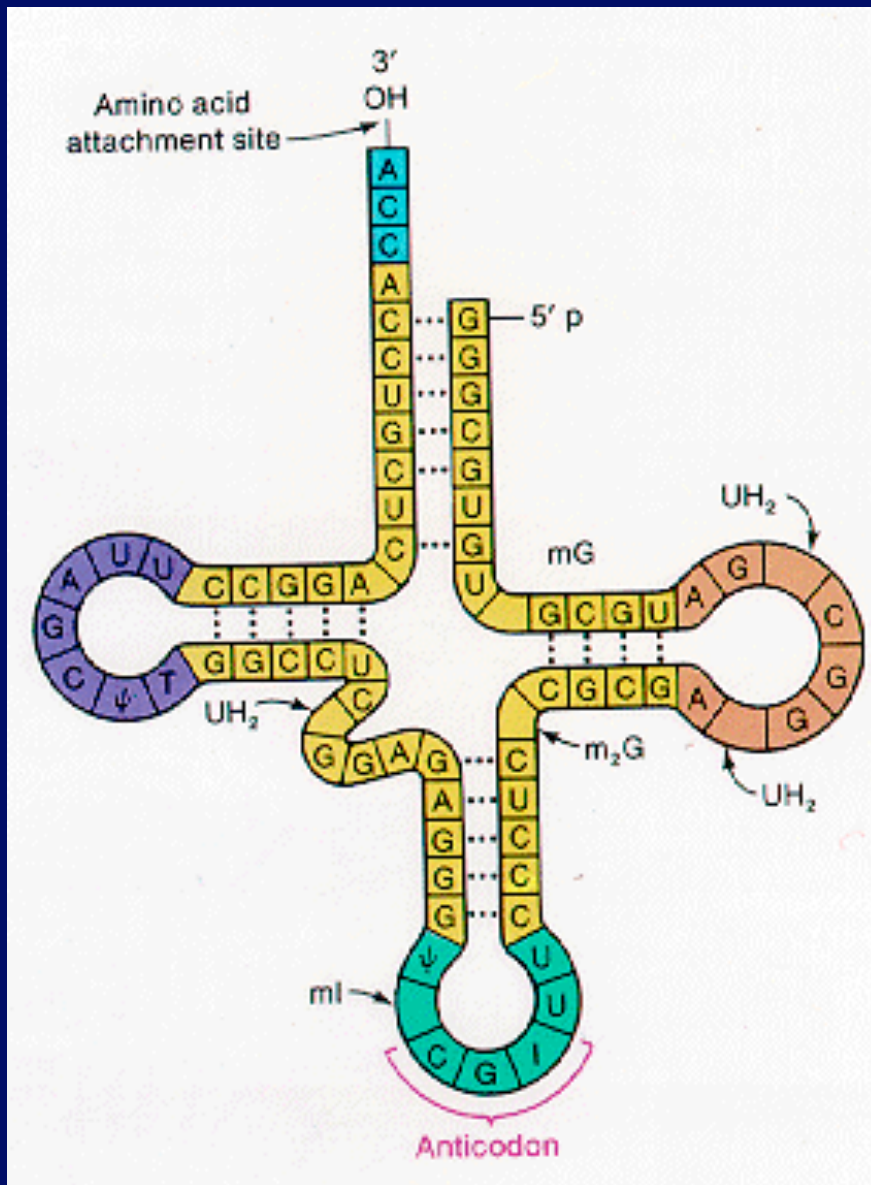

Translation

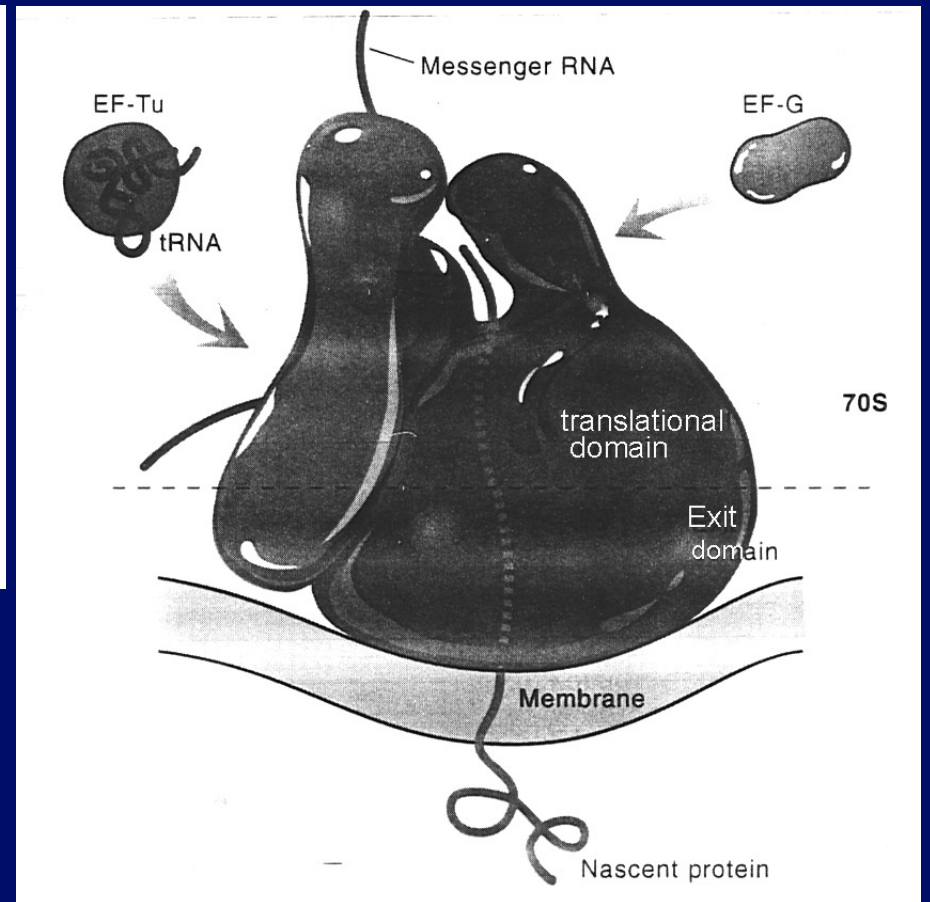
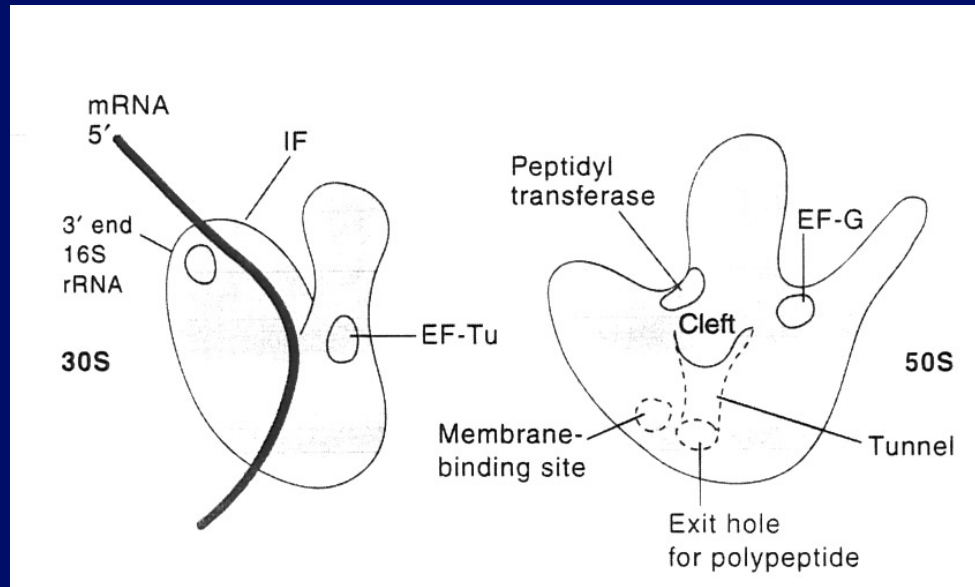

Variations in the Code

1. “Wobble” Bases

The third base in a codon can sometimes vary.

tRNA

U

G

mRNA

A or G

C or U

Comparison to genetic code \Rightarrow no change
in amino acids

For mRNA

Genetic Code

First RNA Base	U	C	A	G	Third RNA BASE
U	Phenylalanine	Serine	Tyrosine	Cysteine	U
	Phenylalanine	Serine	Tyrosine	Cysteine	C
	Leucine	Serine	Stop	Stop	A
	Leucine	Serine	Stop	Tryptophan	G
C	Leucine	Proline	Histidine	Arginine	U
	Leucine	Proline	Histidine	Arginine	C
	Leucine	Proline	Glutamine	Arginine	A
	Leucine	Proline	Glutamine	Arginine	G
A	Isoleucine	Threonine	Asparagine	Serine	U
	Isoleucine	Threonine	Asparagine	Serine	C
	Isoleucine	Threonine	Lysine	Arginine	A
	Start/Methionine	Threonine	Lysine	Arginine	G
G	Valine	Alanine	Aspartic Acid	Glycine	U
	Valine	Alanine	Aspartic Acid	Glycine	C
	Valine	Alanine	Glutamic Acid	Glycine	A
	Valine	Alanine	Glutamic Acid	Glycine	G

Amino Acids

2. Some organisms use slightly different codes, with one or more changes in codon translation.

First seen in mitochondrial DNA.

Now known in some nuclear DNA

The code has evolved since the last common ancestor (But not much).

Summary

1. Atoms needed: H, C, O, N, small amounts of P (phosphorus), S (sulfur)
2. Two basic molecules needed for life: proteins, nucleic acids
3. Both are polymers - made of simpler monomers. The monomers function as words or letters of alphabet. Information is the key.

Summary (cont.)

4. Proteins and nucleic acids closely linked at fundamental level. Communicate through genetic code. All organisms have almost the same genetic code. It must have originated very early in evolution of life.
5. In present day organisms, protein synthesis must be directed by nucleic acids, but nucleic acid reading or replication requires enzymes (proteins). Chicken-Egg problem

Some Movies of Processes

- From the Virtual Cell Animation collection, Molecular and Cellular Biology Learning Center
 - <http://vcell.ndsu.nodak.edu/animations/home.htm>
 - Needs Windows media player
- Another option:
 - http://highered.mcgraw-hill.com/sites/0072507470/student_view0/chapter3/
 - And look for mRNA synthesis and How translation works.